

Lab-on-a-Chip Part 2 – Detection Methods

Prof. Steven S. Saliterman, <http://saliterman.umn.edu/>

Confocal and Widefield Fluorescence Microscopy

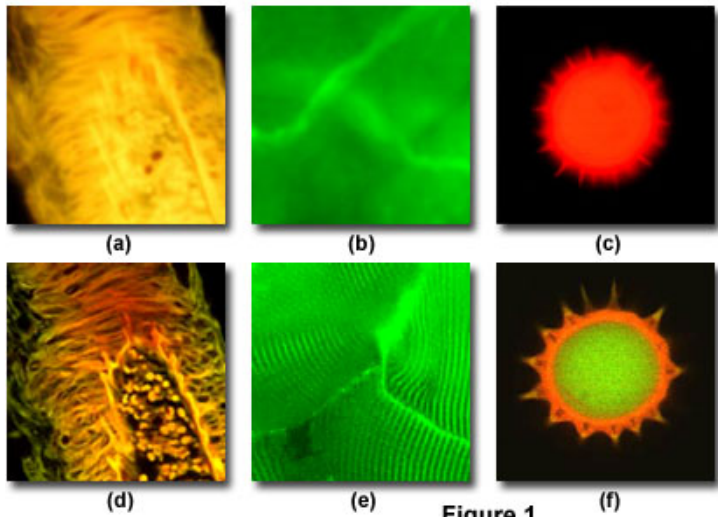
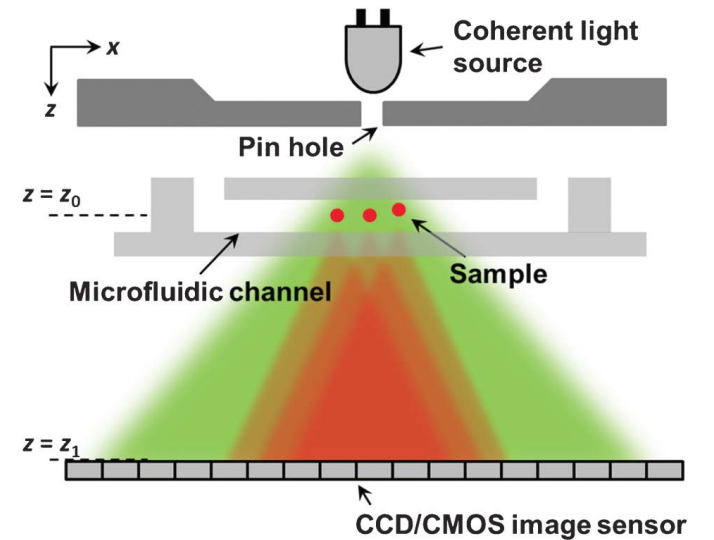
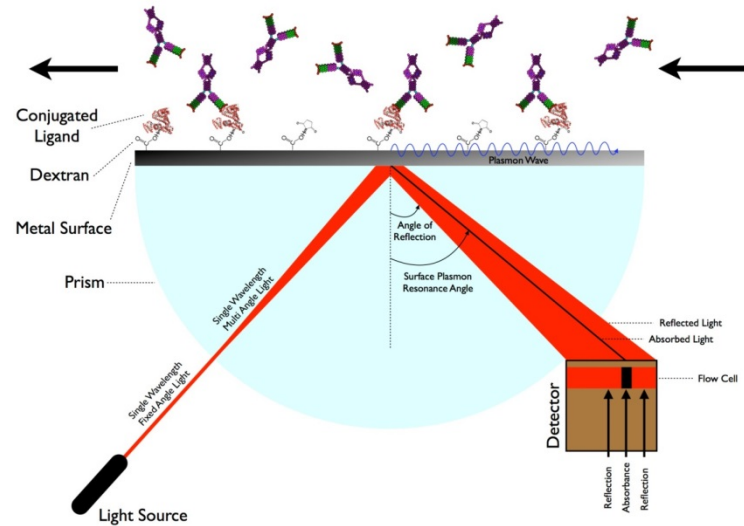

Figure 1



Topics

1. Electrochemical Detection

- *Capillary electrophoresis.*
- *(Electrochemical impedance spectroscopy (EIS) – See Gamry Instrument article)*

2. Optical Detection – Off-Chip

- Absorbance Detection
- Fluorescence Detection
- Chemiluminescence
- Surface Plasmon Resonance
- Surface Enhanced Raman Spectroscopy

3. Optical Detection – On-Chip

- Frequency Specific LEDs
- Absorbance Spectroscopy
- Fluorescence
- Chemiluminescence
- Optical Waveguides
- Surface Plasmon Resonance
- (Interferometry)
- (Holography)

Glass and Polymer Based Devices

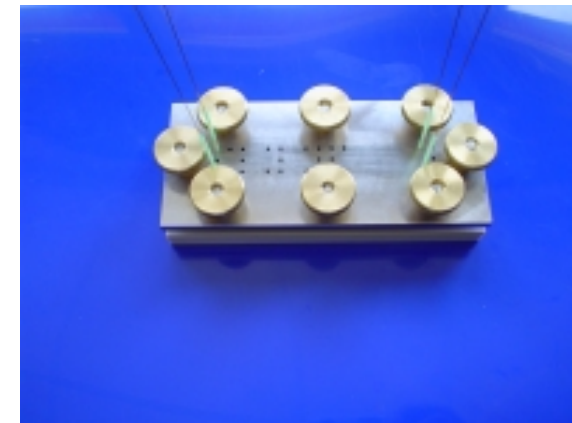
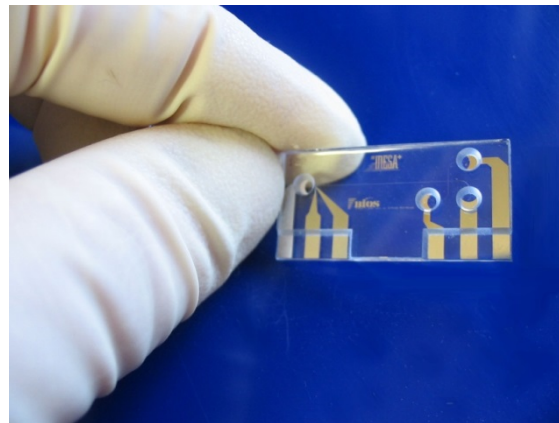
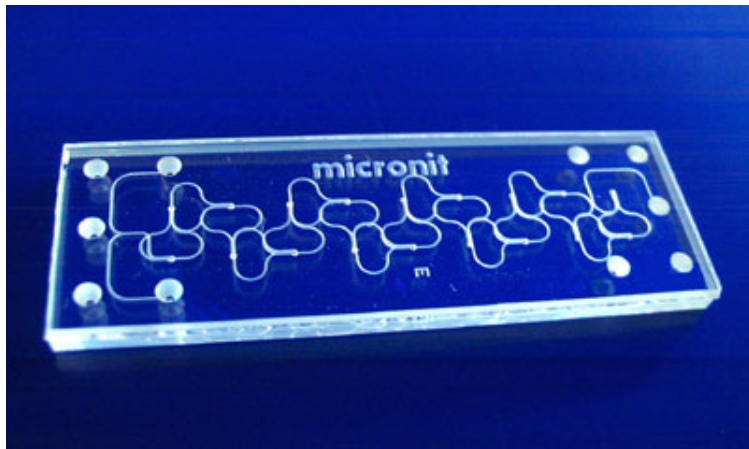
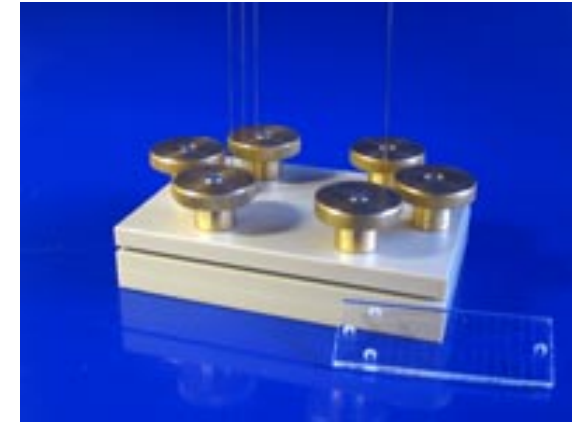
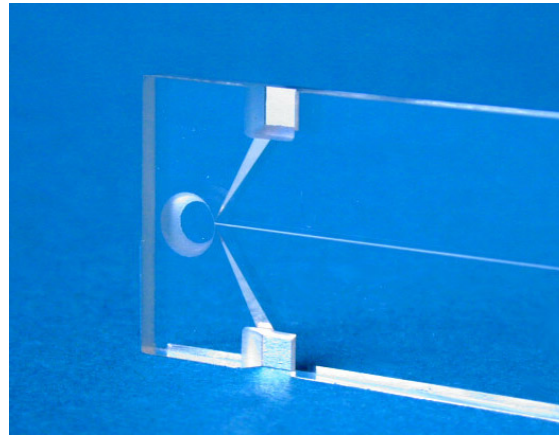
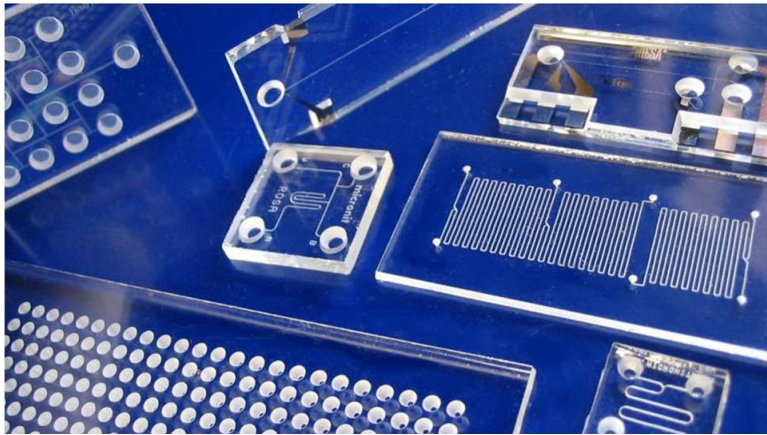

Positive “Downscaling” Effects

- Reduced sample and reagent volumes.
- Ten-fold reduction in length scale.
- Laminar flow (low Reynolds numbers).
- Improved mass flow by diffusion.
- Harvesting electrokinetic effects
- The *surface-to-volume ratio (SVR)* may increase by a factor of more than *ten thousand* during downscaling and solute/wall interactions become dominant.

Consider Capillary Electrophoresis

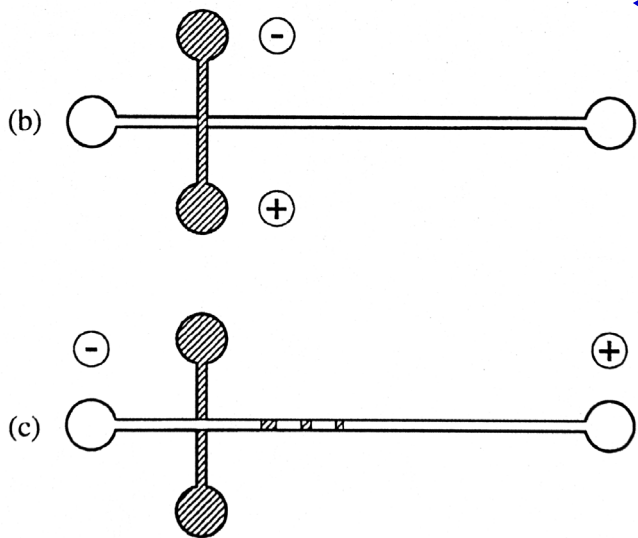
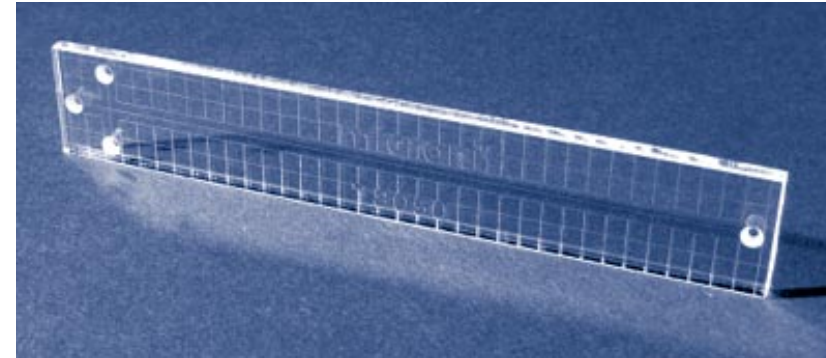
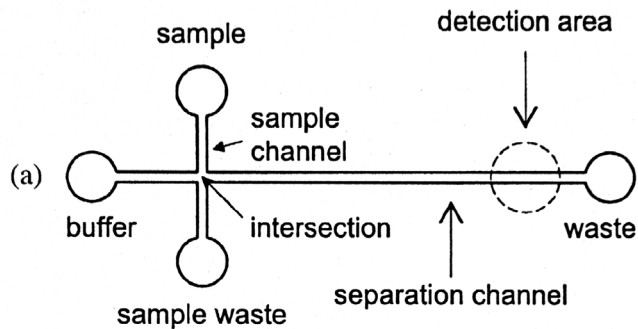

- a) Sample introduction and electrophoretic separation are accomplished in each of two crossing channels.
- b) Sample is driven through the short sample channel across the separation channel by application of a potential, and
- c) The introduced sample “plug” (nanoliter volume) is then electrophoretically separated by application of another potential.

Capillary Electrophoresis...

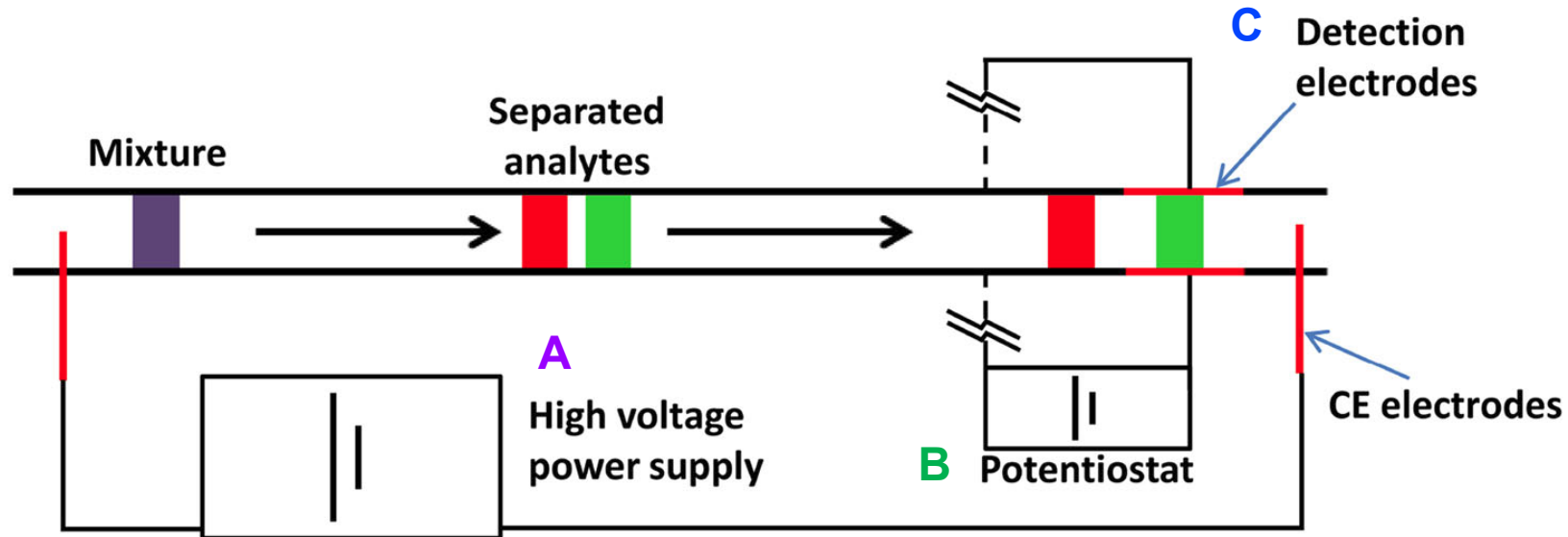

- A. High voltage along the length of the capillary separates the analytes and drives them toward the detection electrodes.
- B. A constant potential is applied with a potentiostat to the detection electrodes.
- C. As each species passes, a change in current or conductivity between the detection electrodes is detected.

Video of Capillary Electrophoresis...

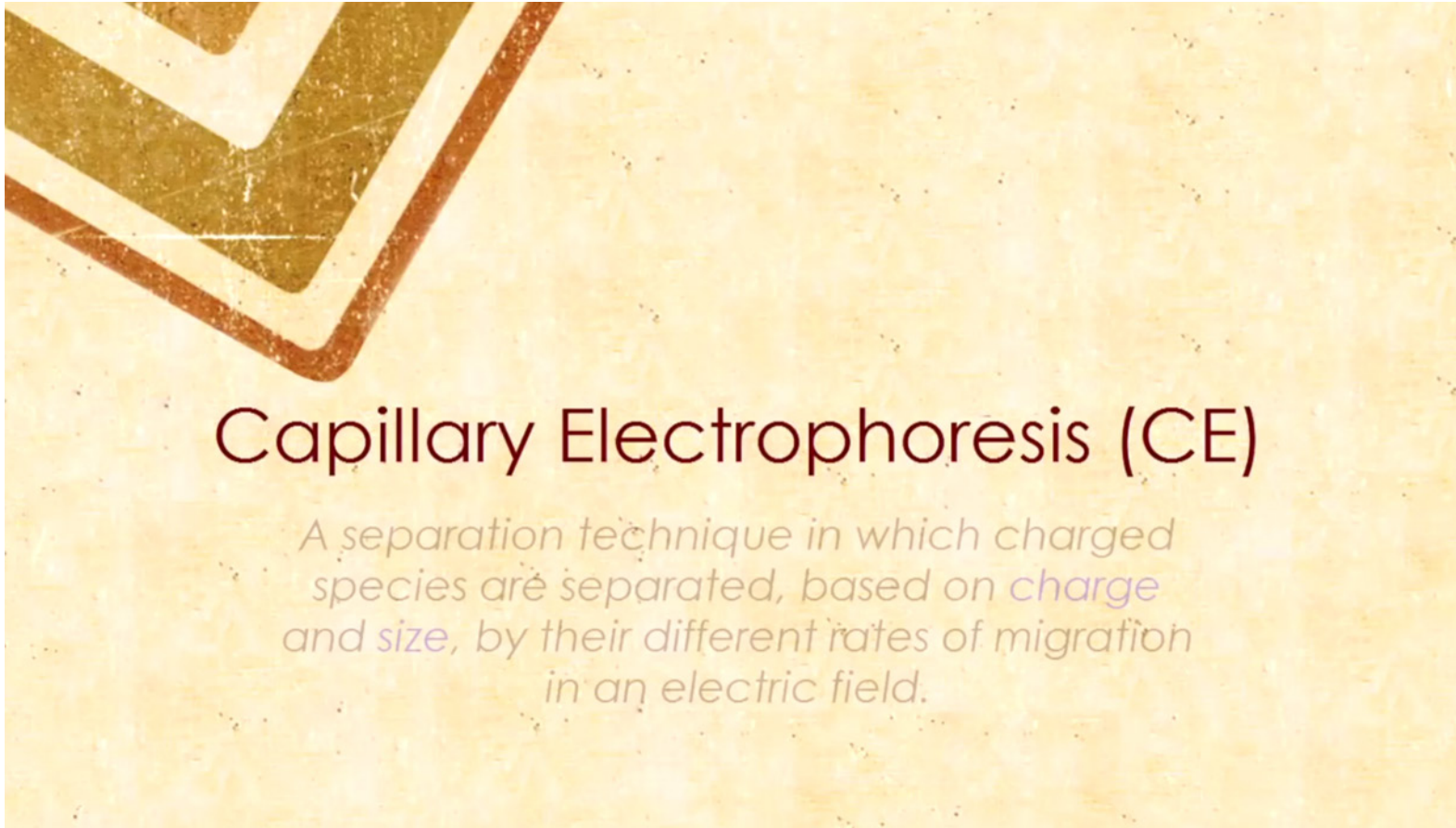

Recall Electrochemical Impedance Spectroscopy (EIS)...

(For a more detailed discussion of EIS see the Gamry Industries article.)

- a) Three-electrode electrochemical cell. (WE = Working Electrode, CE = Counter Electrode, RE = Reference Electrode & V = Voltage).
- b) On the left, a small AC voltage is applied across the WE and RE of a three-electrode electrochemical cell.
- c) Current is then measured from the WE to the CE and varies with frequency and the analyte concentration.

a) Gencoglu, A and Adrienne R. Minerick . Electrochemical detection techniques in micro- and nanofluidic devices. *Microfluid Nanofluid* (2014) 17:781–807

b) Fan L, Zhao G, Shi H, Liu M, Li Z (2013) A highly selective electrochemical impedance spectroscopy-based aptasensor for sensitive detection of acetamiprid. *Biosens Bioelectron* 43:12–18. doi:10.1016/j.bios.2012.11.033

What is Impedance?

- **Impedance (Z)** – Total opposition a device or circuit offers to flow of an *alternating current* at a given *frequency*.
 - Units are in ohms
 - Complex quantity graphically shown on a vector plane (real and imaginary parts): $R + jX$ where R is *resistance* and X *reactance*

Recall Aptamers...

- Aptamers are **artificial nucleic acid ligands** that can be generated against amino acids, drugs, proteins and other molecules.
- Function similar to **antibodies**.
- **Applications:**
 - Therapeutics,
 - Target validation,
 - Drug screening,
 - Affinity separation,
 - Diagnostics and biosensors.

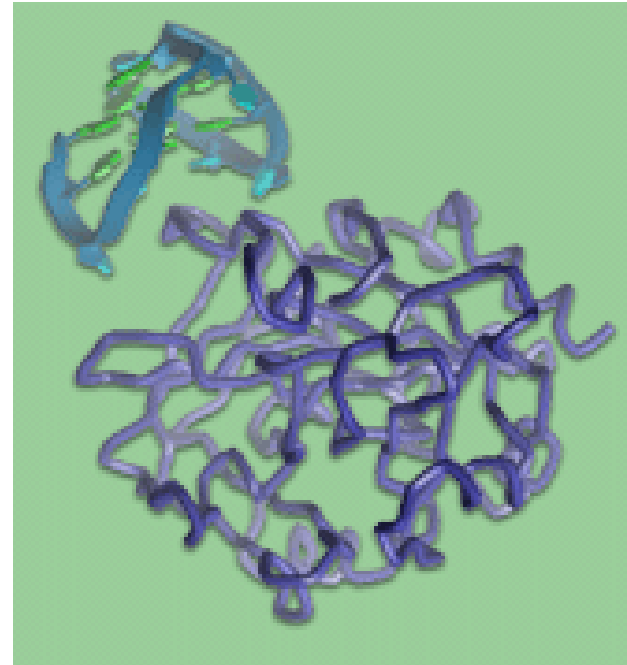

Optical Detection: Off-Chip

- Absorbance Detection
- Fluorescence Detection
- Chemiluminescence
- Surface Plasmon Resonance
- Localized Surface Plasmon Resonance (LSPR)
Spectroscopy (electromagnetic-field enhancement that leads to surface enhanced Raman Scattering and other surface-enhanced processes)

Absorbance Detection

- UV/Visible light is used for absorption spectroscopy.
- Absorption spectra are related to the structure and concentration of the analyte and are based on the capability of samples to attenuate the incident electromagnetic radiation at various wavelengths.

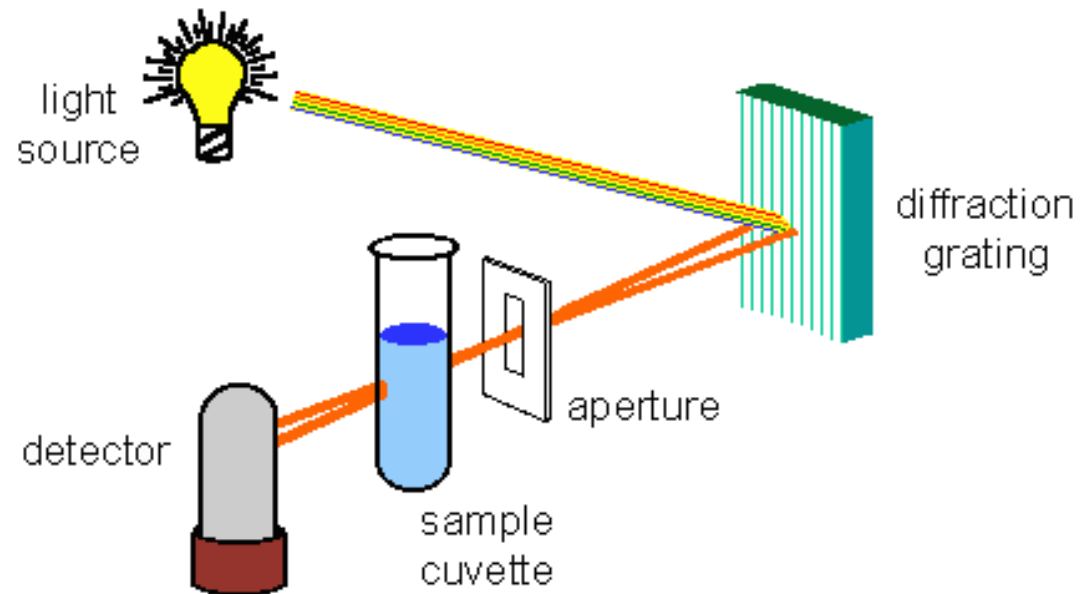

© 2001 B. M. Tissue

Introducing Fluorophores...

- A *fluorophore* is a fluorescent chemical compound that may re-emit light upon light excitation.
- Fluorophores typically contain several combined aromatic groups, or plane or cyclic molecules with several π bonds.
- Generally covalently bonded to a macromolecule, serving as a marker (or dye, or tag, or reporter) for affine or bioactive reagents (antibodies, peptides, nucleic acids).
- Fluorophores are notably used to stain tissues, cells, or materials in a variety of analytical methods.

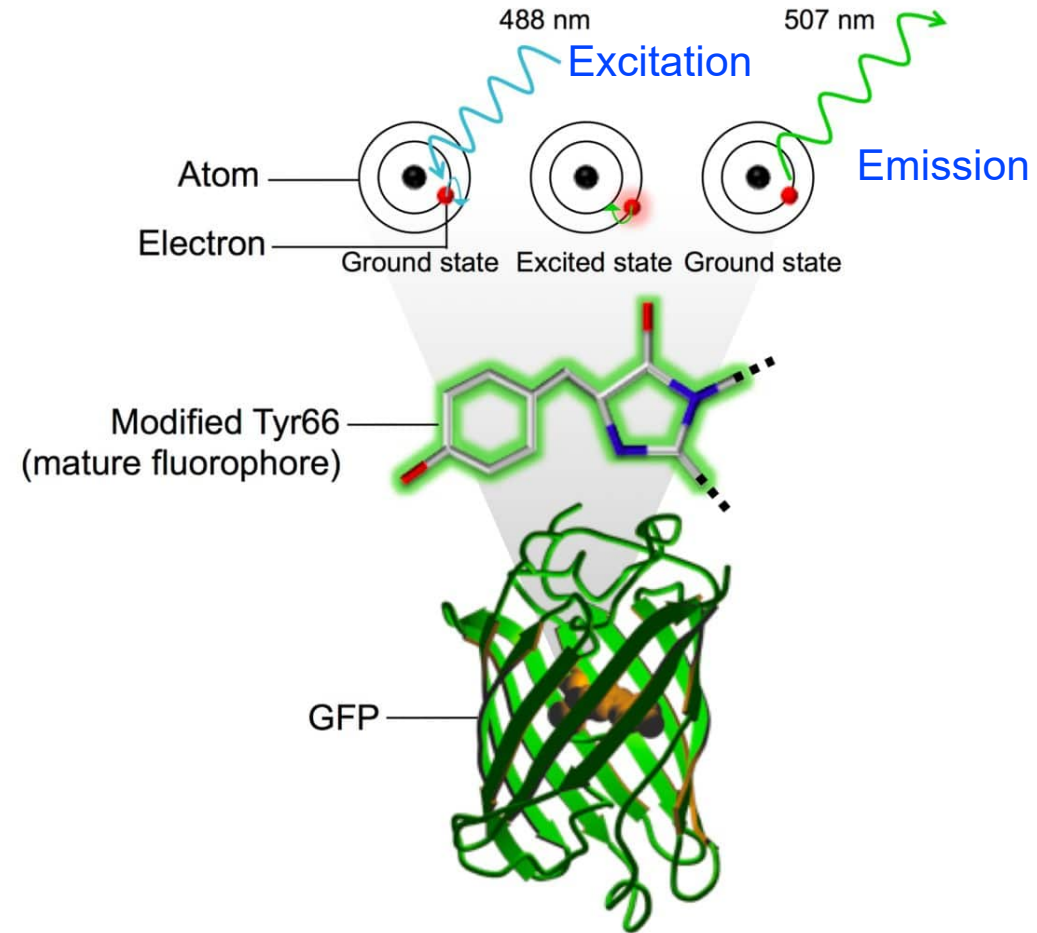

Wikipedia.org

Nat. Inst. of General Medical Sciences, NIH

Fluorophore Characteristics

- **Maximum excitation and emission wavelength** (nm):
 - Corresponds to the peak in the excitation and emission
- **Extinction Coefficient** ($\text{Mol}^{-1}\text{cm}^{-1}$):
 - Links the quantity of absorbed light, at a given wavelength, to the concentration of fluorophore in solution.
- **Quantum yield** (emitted/absorbed photons):
 - Efficiency of the energy transferred from incident light to emitted fluorescence
- **Lifetime** (in picoseconds):
 - Duration of the excited state of a fluorophore before returning to its ground state
- **Stokes shift**:
 - Difference between the max excitation and max emission wavelengths.

Introducing Molecular Beacons...

- Single-stranded oligonucleotide hybridization probes that form a stem-and-loop structure:

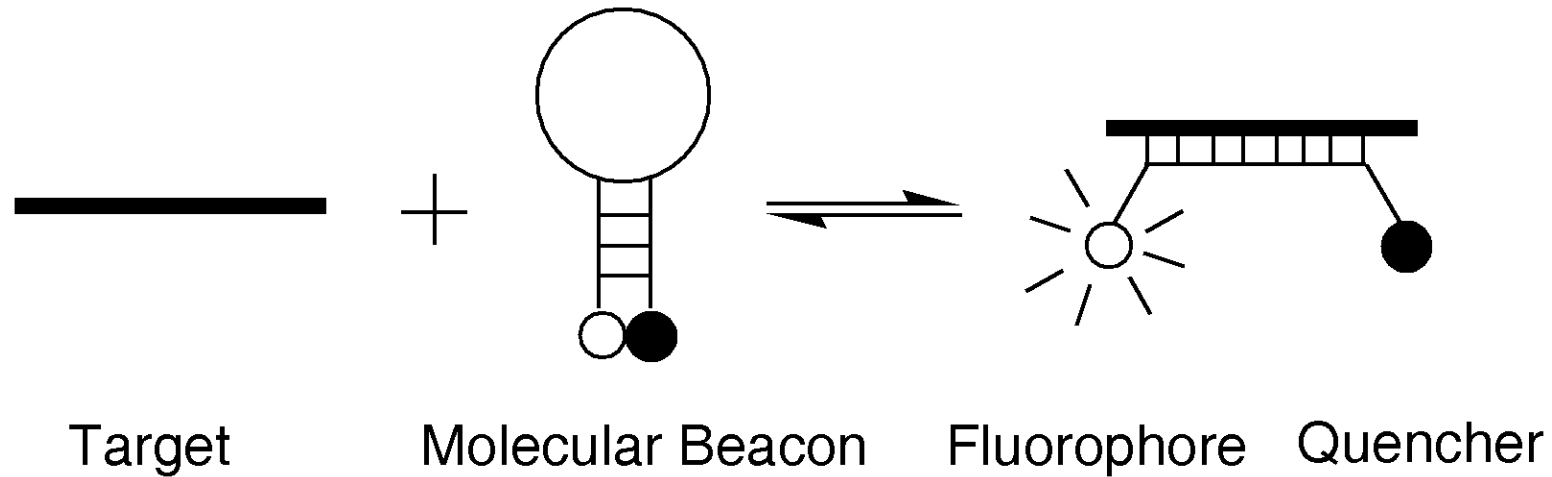

Molecular Beacons...

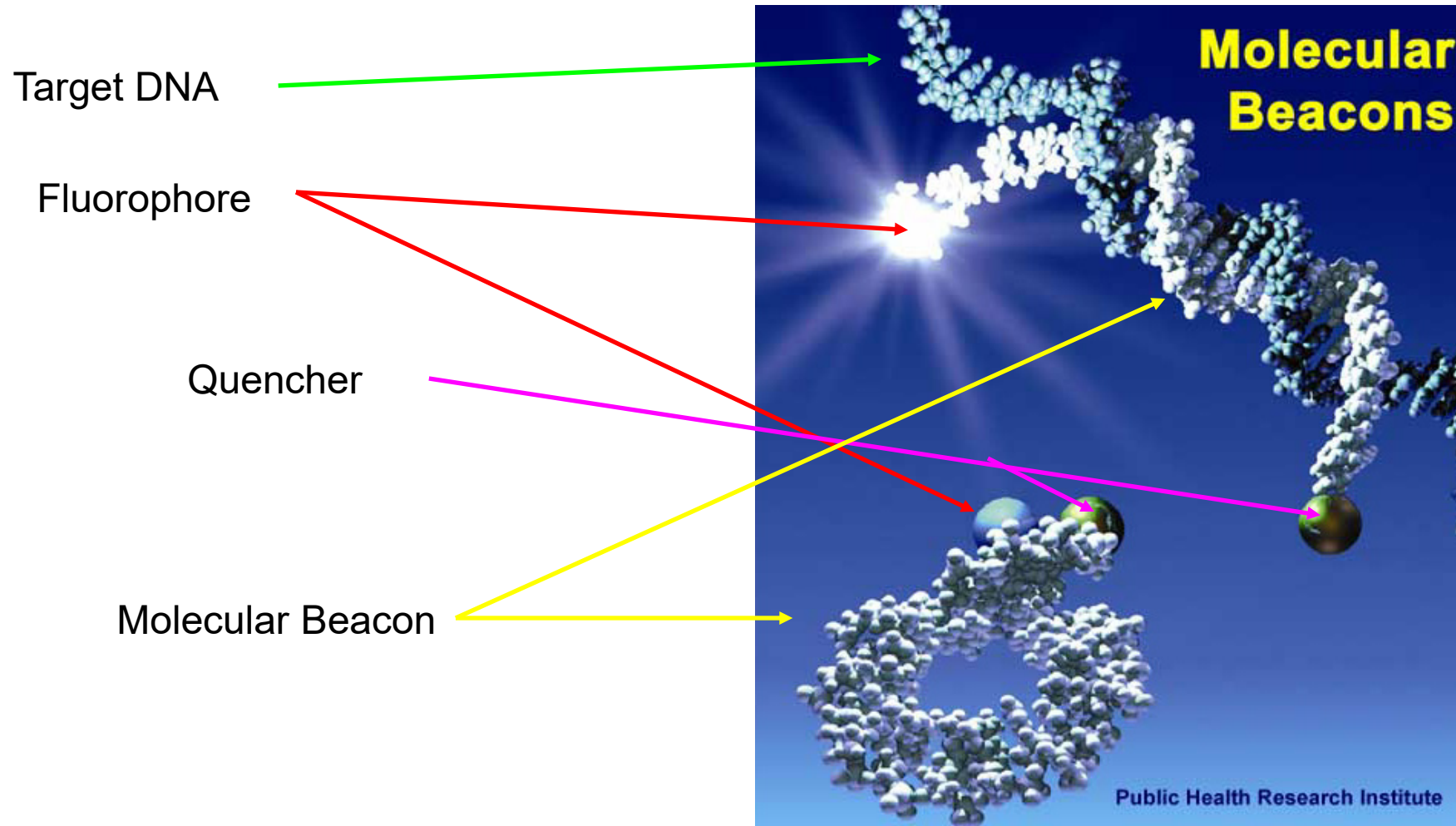

Confocal Scanning Laser Microscopy...

Confocal and Widefield Fluorescence Microscopy

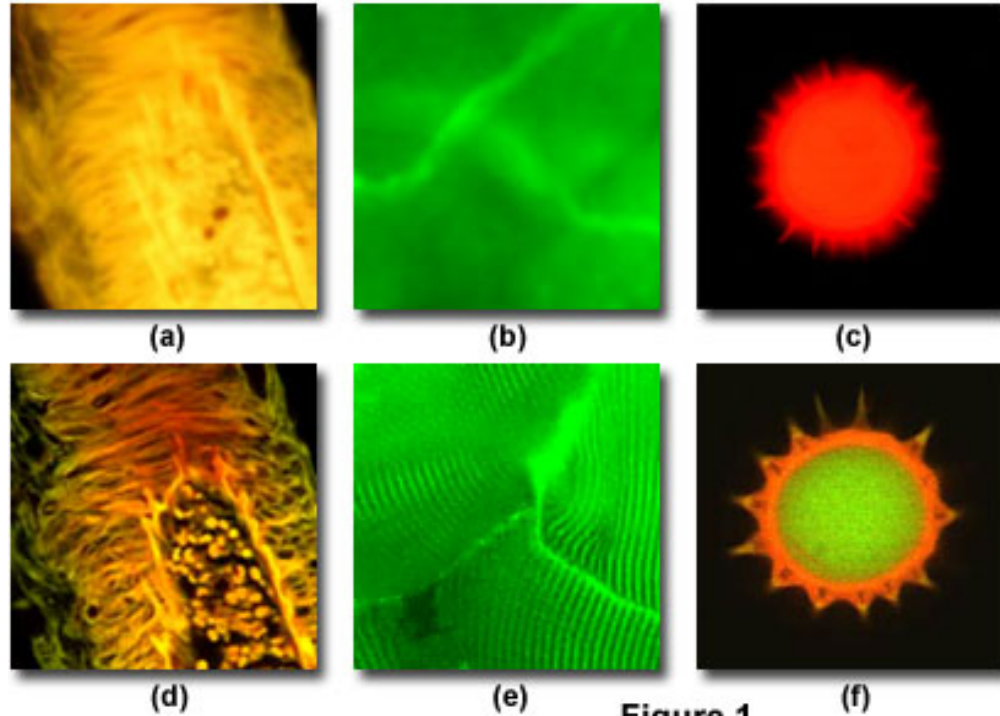

Human
Medulla

Rabbit
Muscle
Fiber

Sunflower
Pollen Grain

Figure 1

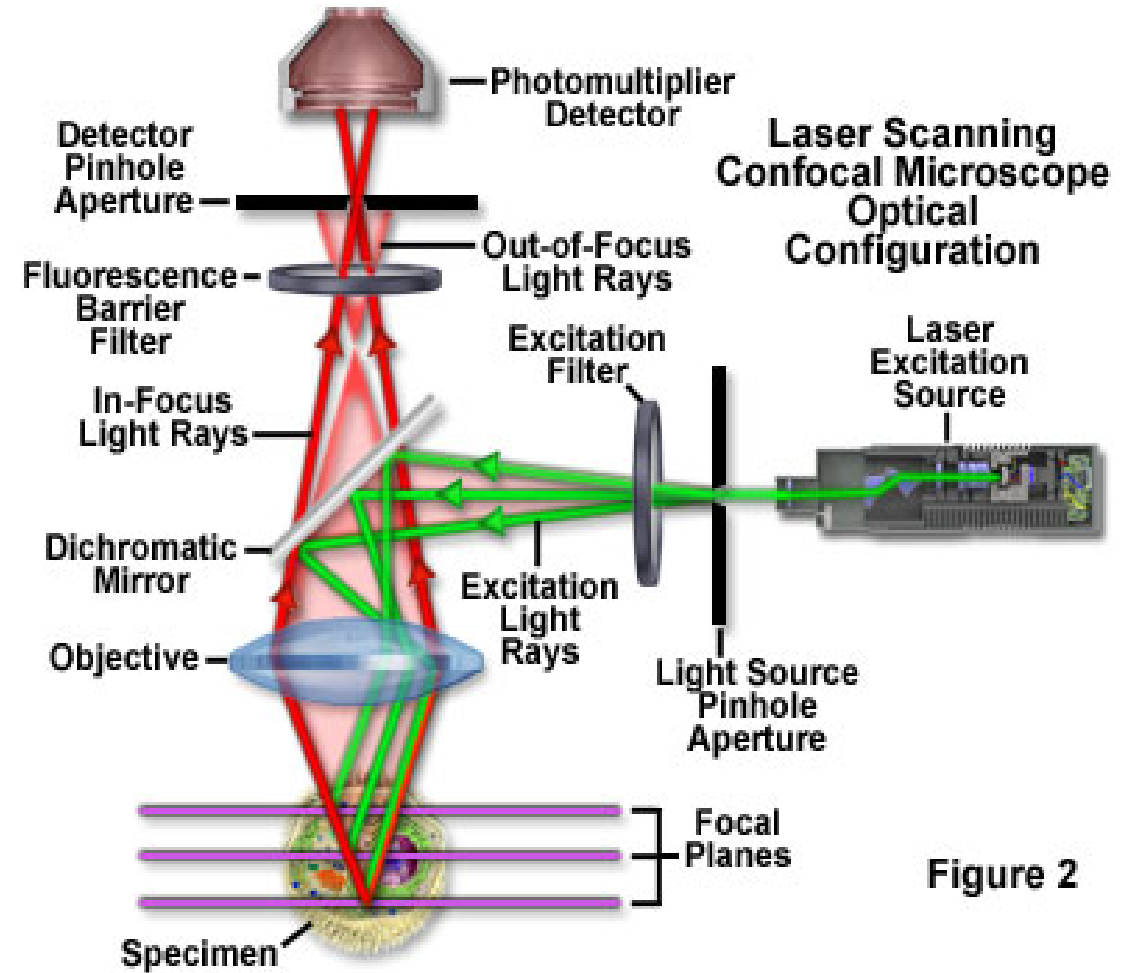

Figure 2

Chemiluminescence

- **Chemiluminescence** (CL) is the generation of light (visible, ultraviolet and infrared) by the release of energy from a chemical reaction.
- **Advantages:**
 - No excitation source (as does fluorescence and phosphorescence),
 - Only a single light detector such as a photomultiplier tube,
 - No monochromator and often not even a filter.
- Detection limits can be 10 to 100 times lower than other luminescence techniques.
- **Peroxyoxalates** are esters formed by the reaction of hydrogen peroxide and oxalate esters.

Peroxyoxalate Chemiluminescence

- Peroxyoxalate “light-stick” reaction and emission from the reaction of luminol with hydrogen peroxide in basic aqueous solution catalyzed by cobalt II:

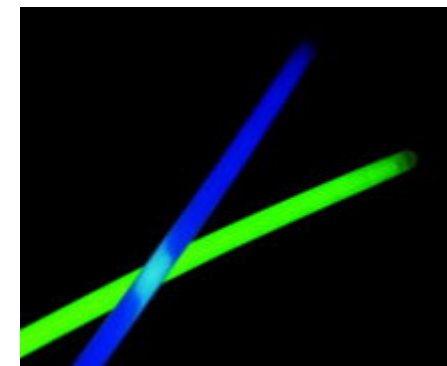

Surface Plasmon Resonance

- Resonant oscillation of conduction electrons at the interface between a metal surface and surrounding medium, stimulated by incident light.
- The dielectric material (like air or glass) surrounding the metal has a positive value for its permittivity (ϵ), while the metal itself has a negative permittivity ($-\epsilon$).
- Detection is possible because adsorbing molecules cause changes in the local index of refraction, changing the resonance conditions of the surface plasmon waves.

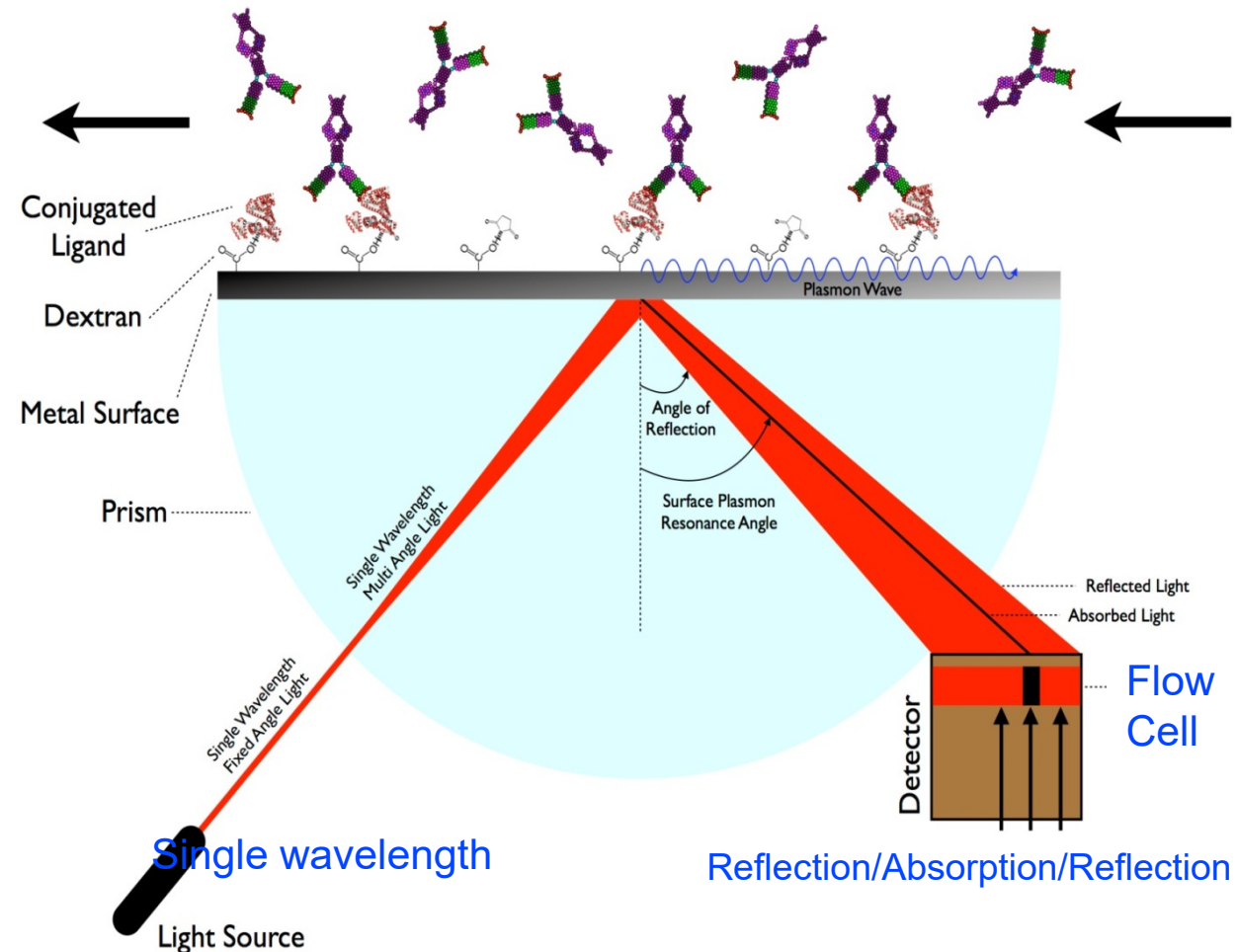

- When light strikes the metal surface at a specific angle, its electric field couples with the electrons on the metal surface, causing them to oscillate collectively like a wave.
 - This oscillation is most pronounced when the frequency of the incident light matches the natural frequency of the electrons, leading to a *resonant response*.
- **Permittivity:** A measure of how a material polarizes in response to an electric field.
 - **Positive permittivity:** Indicates a material that readily polarizes in the direction of an applied electric
 - **Negative permittivity:** Indicates a material where the electrons can collectively oscillate against the applied electric field, typically seen in metals at certain wavelengths.

SPR...

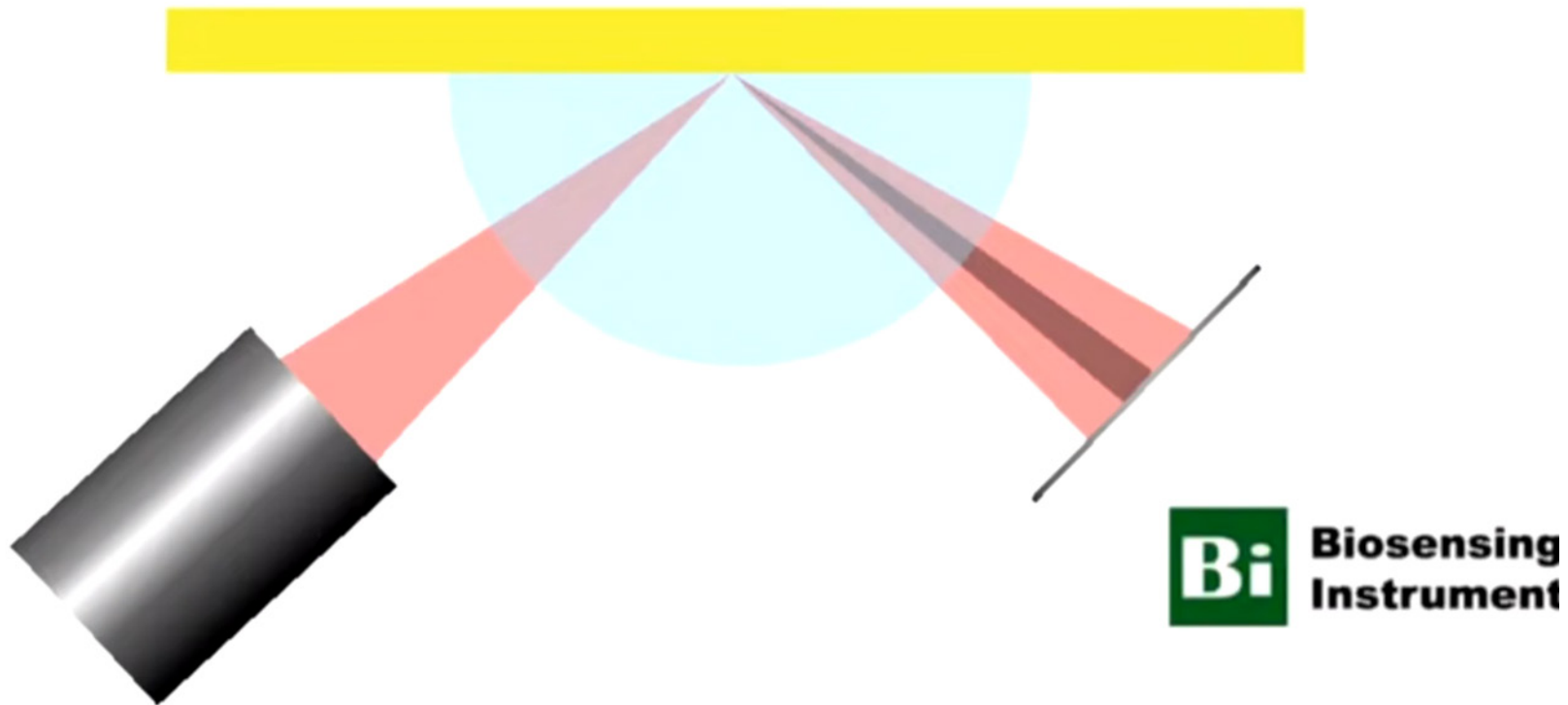

What are Surface Plasmons?

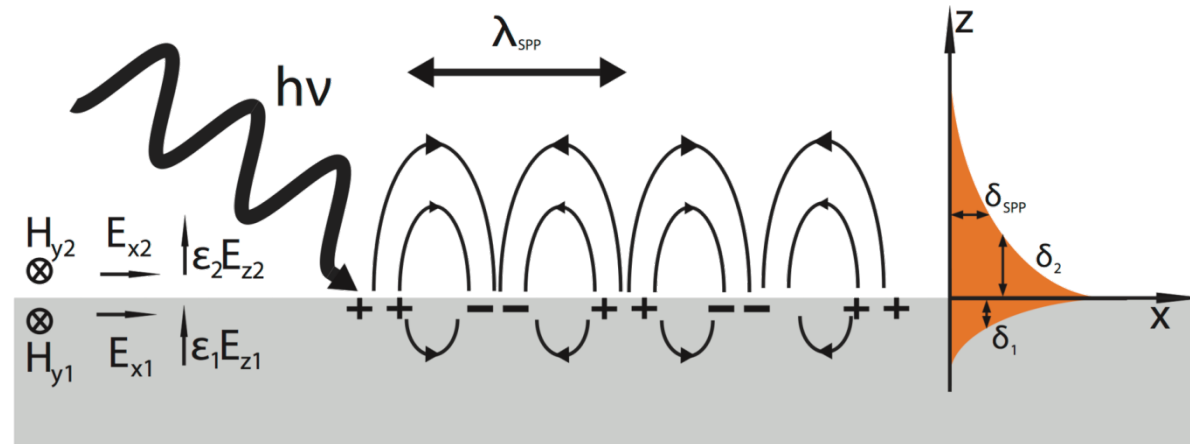

- Coherent delocalized electron oscillations that exist at the interface between any two materials.
- Surface plasmon polaritons are surface electromagnetic waves that propagate in a direction parallel to the metal/dielectric (or metal/vacuum) interface.
- Since the wave is on the boundary of the metal and the external medium (air or water for example), these oscillations are very sensitive to any change of this boundary, such as the adsorption of molecules to the metal surface.

Localized SPR Explained...

- **Localized surface plasmon resonance (LSPR) spectroscopy** of metallic nanoparticles is a powerful technique for chemical and biological sensing experiments
- **Materials that possess a negative real and small positive imaginary dielectric constant** are capable of supporting a surface plasmon resonance (SPR).
- **Plasmonics** is the study of these particular light-matter interactions

“Localized” Surface Plasmon Resonance

- Basis for measuring adsorption of material onto planar metal (typically gold and silver) surfaces or onto the surface of metal nanoparticles.
 - Surface plasmon polariton (or propagating plasmon).
 - Localized surface plasmon. Light interacts with particles much smaller than the incident wavelength.
 - This leads to a plasmon that oscillates locally around the nanoparticle with a frequency known as the LSPR. Similar to the SPR, the LSPR is sensitive to changes in the local dielectric environment.

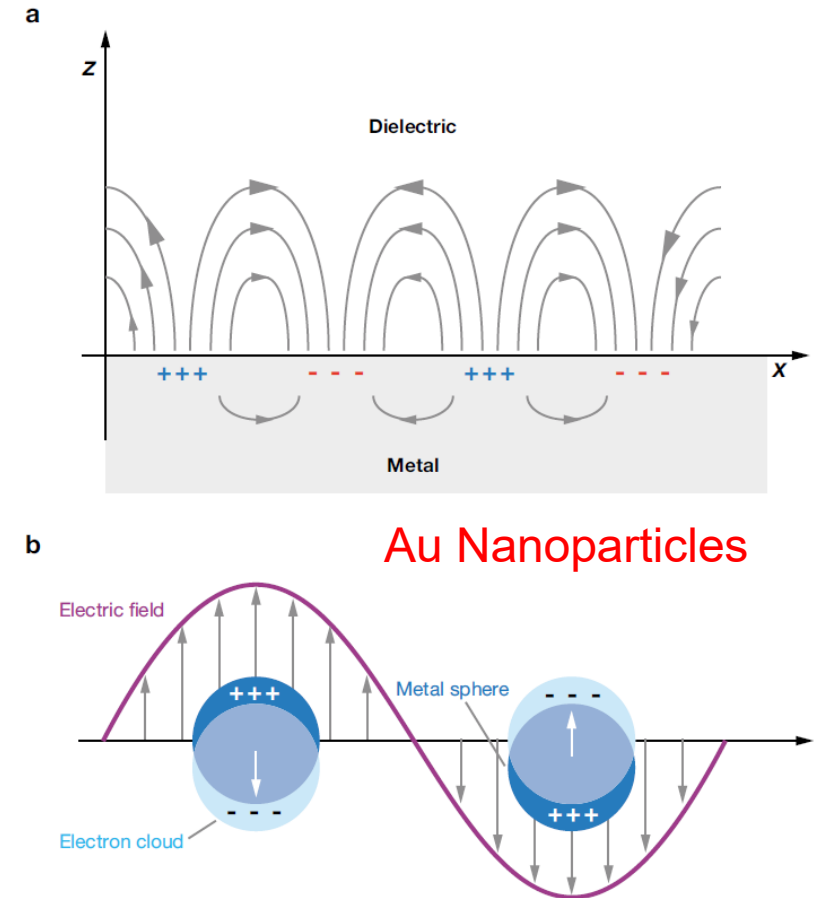

Optical Detection: On-Chip

- Frequency Specific LEDs
- Absorbance Spectroscopy
- Fluorescence
- Chemiluminescence
- Optical Waveguides
- Surface Plasmon Resonance
- (Interferometry)
- (Holography)

Introducing LEDs...

Spectral Profiles of LEDs for Fluorescence Microscopy

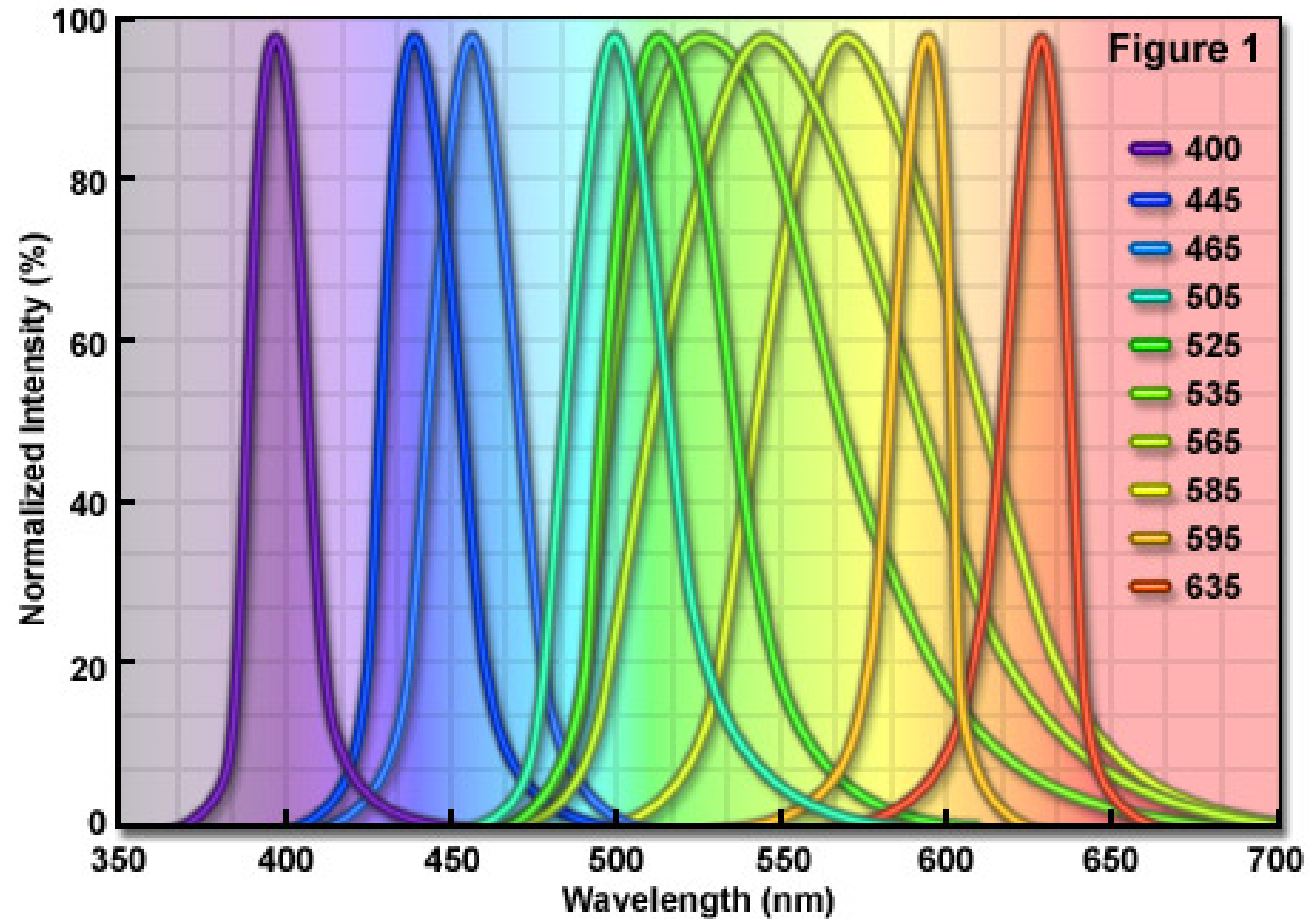

Absorbance Spectroscopy On-Chip

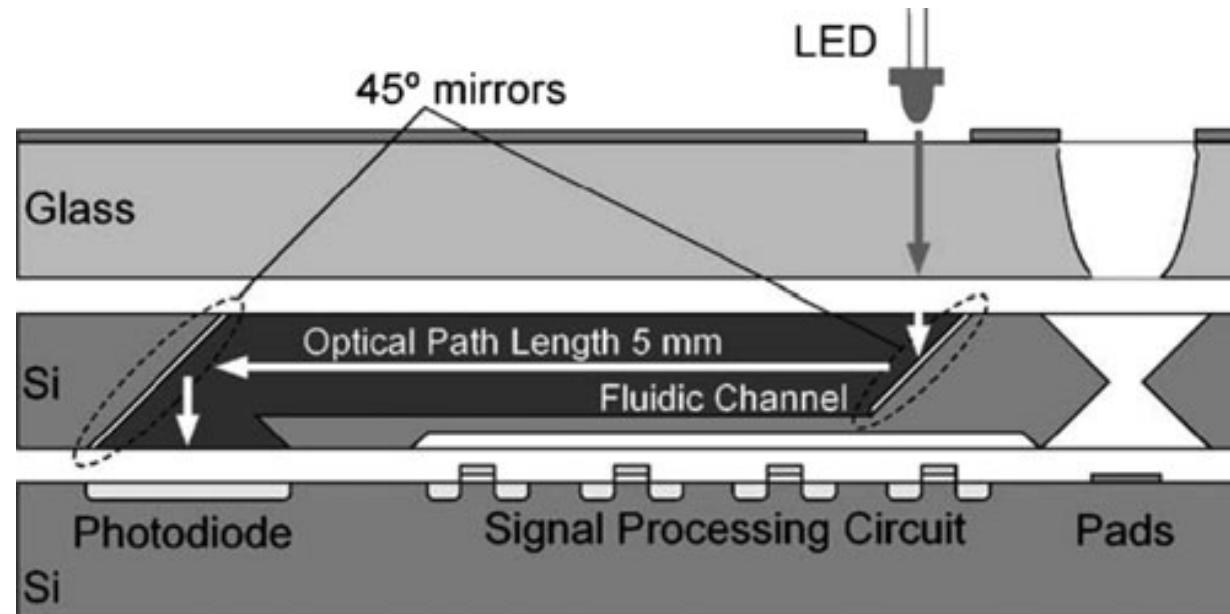

Increasing optical path length by making the light pass axially between parallel 45° mirrors.

Noda T, Takao H, Yoshioka K, Oku N, Ashiki M, Sawada K, Matsumoto K, Ishida M(2006) *Sens Actuators B* 119:245–250

Gai, Hongwei, Yongjun Li, and Edward S. Yeung. 2011. Optical Detection Systems on Microfluidic Chips. *Microfluidics: Technologies and Applications* 304, 171-201.

Fluorescence

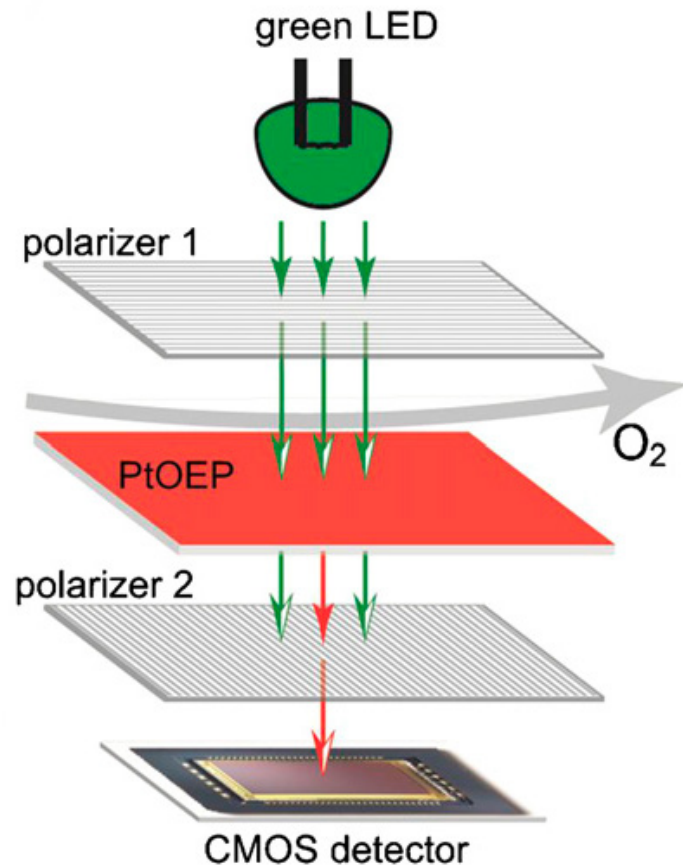

Conceptual design of a fluorescence-based detection device showing a light source (LED), photodetector (CMOS), polarizers and O₂ sensitive PtOEP* film arranged in a portable O₂ sensing system.

*Platinum Octaethyl Porphyrin

Chemiluminescence

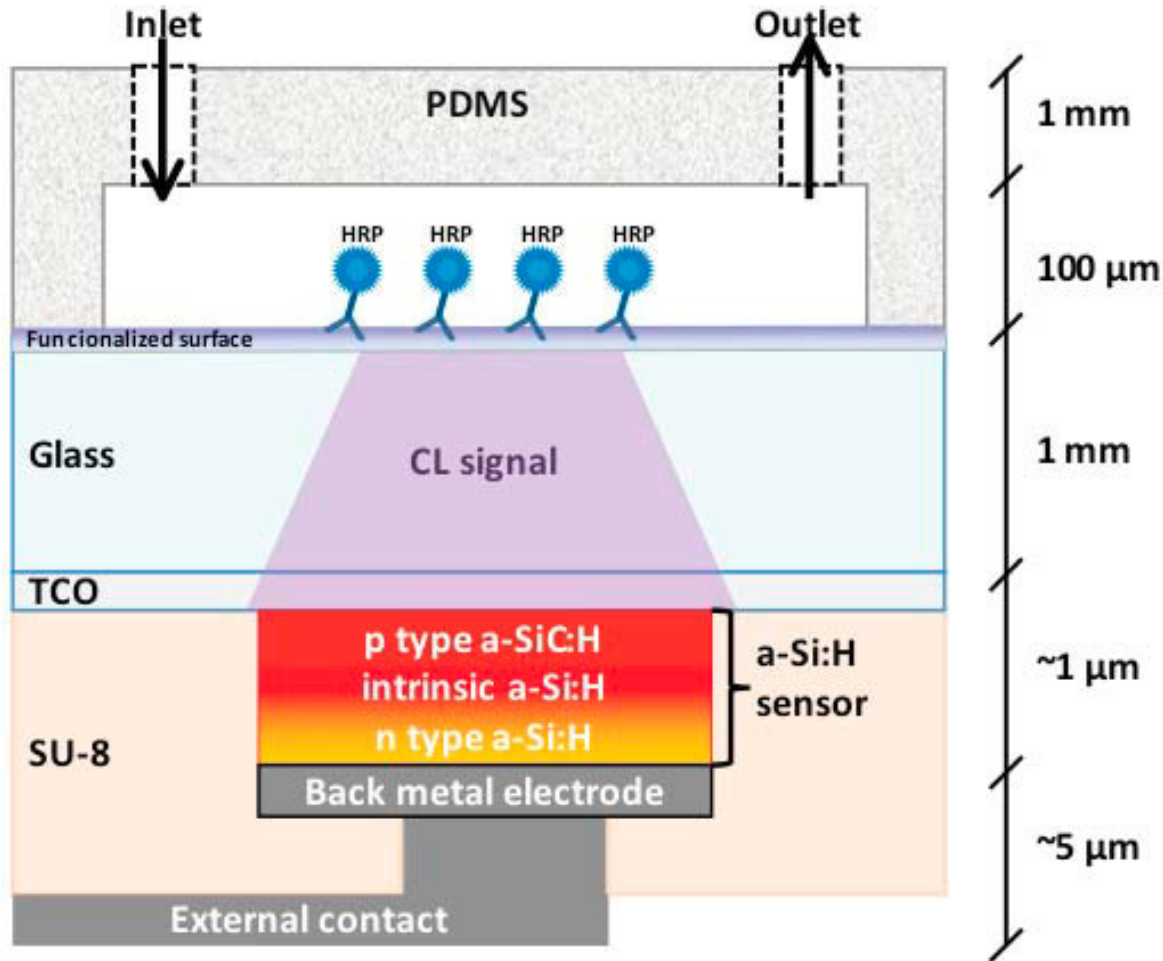

Integrated opto-microfluidic sensor with a hydrogenated amorphous silicon (a-Si:H) photodetector prepared onto a glass substrate covered by a transparent conductive oxide (TCO) film.

Waveguides for LOC based on Refractive Index

1. Solid-state waveguides.

- Solid fibers (silica, glass or polymer) enter the chip and intersect the fluidic channel, exciting analytes and collecting the response.

2. Liquid-core waveguides (LCWs).

- The microchannel not only transports the sample, but also transmits the light.
- If liquid (particularly water in a microfluidic chip, with refractive index of 1.33) is used as the core of waveguide, the refractive indices of the cladding should be smaller.

3. Liquid-core/liquid-cladding (L^2) waveguides

- Two or more different laminar liquids of different refractive index flowing inside a fluidic channel.
- The index of the cladding liquid is smaller than that of the core liquid so that the light is guided in the channel by the total internal reflection.

Liquid-Core/ Cladding (L^2) Waveguide

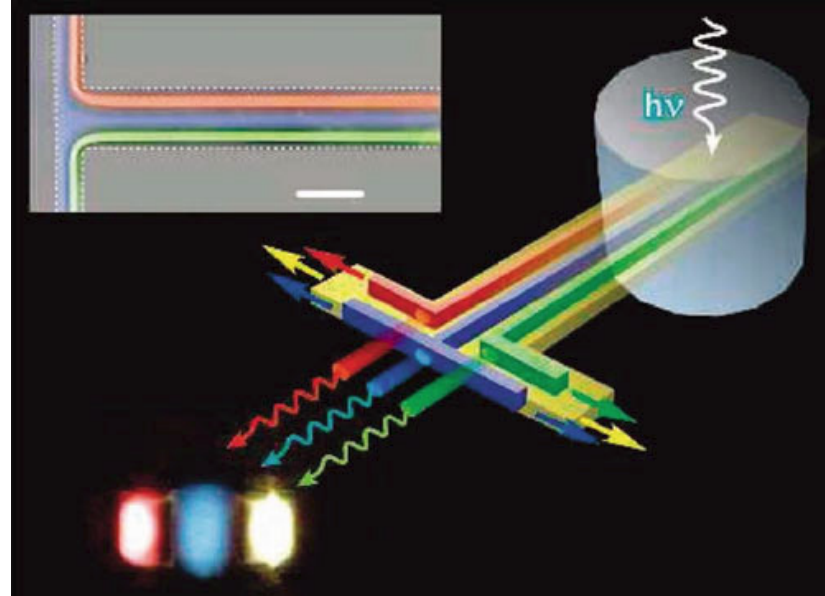

Three parallel waveguides formed with liquid core and cladding in laminar flow systems. The direction of the light propagation can be altered by different flow rates of the adjacent fluids.

Gai, Hongwei, Yongjun Li, and Edward S. Yeung. 2011. Optical Detection Systems on Microfluidic Chips. *Microfluidics: Technologies and Applications* 304, 171-201.

Ligler FS (2009) *Anal Chem* 81:519–526

Surface Plasmon Resonance On-Chip

Coupling schemes of incident light to surface plasmons.

Traditional Prism Coupling

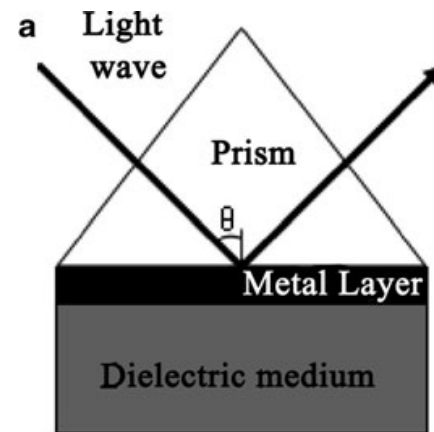

Fiber Optic SPR Sensor

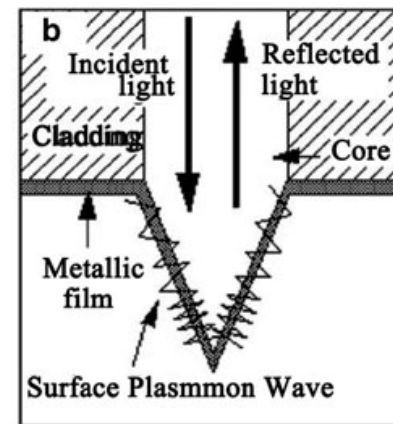

Waveguide Coupling

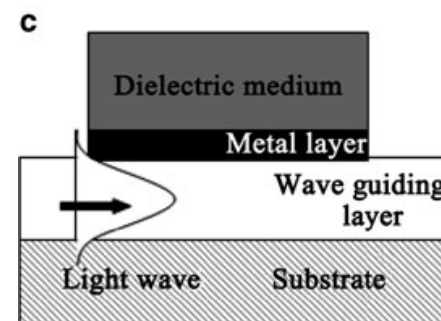

Grating Coupling

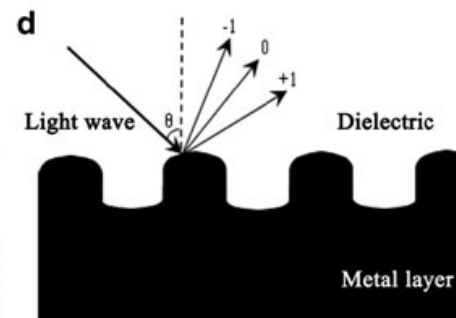

Key Points

- **Positive downscaling effects include:**
 - Reduced sample and reagent volumes.
 - Ten-fold reduction in length scale.
 - Laminar flow (low Reynolds numbers).
 - Improved mass flow by diffusion.
 - Harvesting electrokinetic effects.
 - The surface-to-volume ratio (SVR) may increase by a factor of more than ten thousand during downscaling and solute/wall interactions become dominant.

Key Points...

- In capillary electrophoresis high voltage is applied along the length of the capillary, separating the analytes and drives them toward the detection electrodes.
 - A constant potential is applied with a potentiostat to the detection electrodes.
 - As each species passes, a change in current or conductivity between the detection electrodes is detected.
- Aptamers are artificial nucleic acid ligands that can be generated against amino acids, drugs, proteins and other molecules. Function similar to antibodies.

Key Points...

- Optical Detection - Conventional Off-Chip or “Free-Space”
 - Absorbance Detection
 - Fluorescence Detection
 - Chemiluminescence
 - Surface Plasmon Resonance
 - Surface Enhanced Raman Spectroscopy
- Optical Detection - Chip Methods
 - Frequency Specific LEDs
 - Absorbance Spectroscopy
 - Fluorescence
 - Chemiluminescence
 - Optical Waveguides
 - Surface Plasmon Resonance

Key Points...

- A fluorophore is a fluorescent chemical compound that may re-emit light upon light excitation. Fluorophores are notably used to stain tissues, cells, or materials in a variety of analytical methods.
- Molecular beacons are single-stranded oligonucleotide hybridization probes that form a stem-and-loop structure.
- Chemiluminescence (CL) is the generation of light (visible, ultraviolet and infrared) by the release of energy from a chemical reaction.
- Surface Plasmon Resonance - oscillation of conduction electrons at the interface between a negative and positive permittivity material stimulated by incident light.
 - Detection is possible because adsorbing molecules cause changes in the local index of refraction, changing the resonance conditions of the surface plasmon waves.

Appendix

- Examples of EIS
- Detection of cancer markers
- Table of Chemiluminescence Detection
- Table of Fluorescence Detection
- SPR Sensing Approach
- Interferometry
- Holographic Techniques

Example of an EIS Implementation...

- Typically applications depend on a specific binding event between the analyte and a recognition element (e.g., enzyme, DNA probe, and antigen), which form a surface layer on the detection electrode, bound directly or through a linker molecule, as shown.
- Shown is modification of an Au working electrode surface for selective detection of the analyte acetamiprid via specific analyte–aptamer binding.

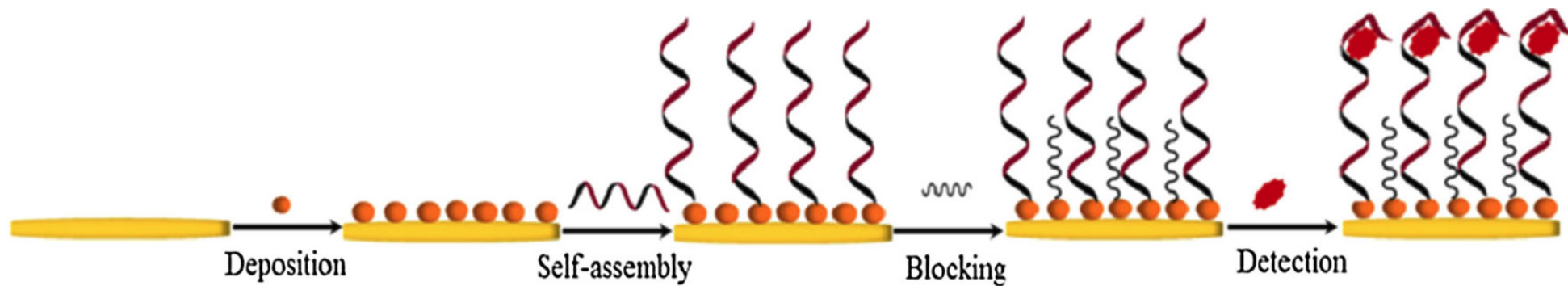

- The bare Au surface plot is shown leftmost. The spectra changes as the surface is functionalized with Au nanoparticles, aptamer, and a blocking agent to block nonspecific binding sites on the aptamer molecule.

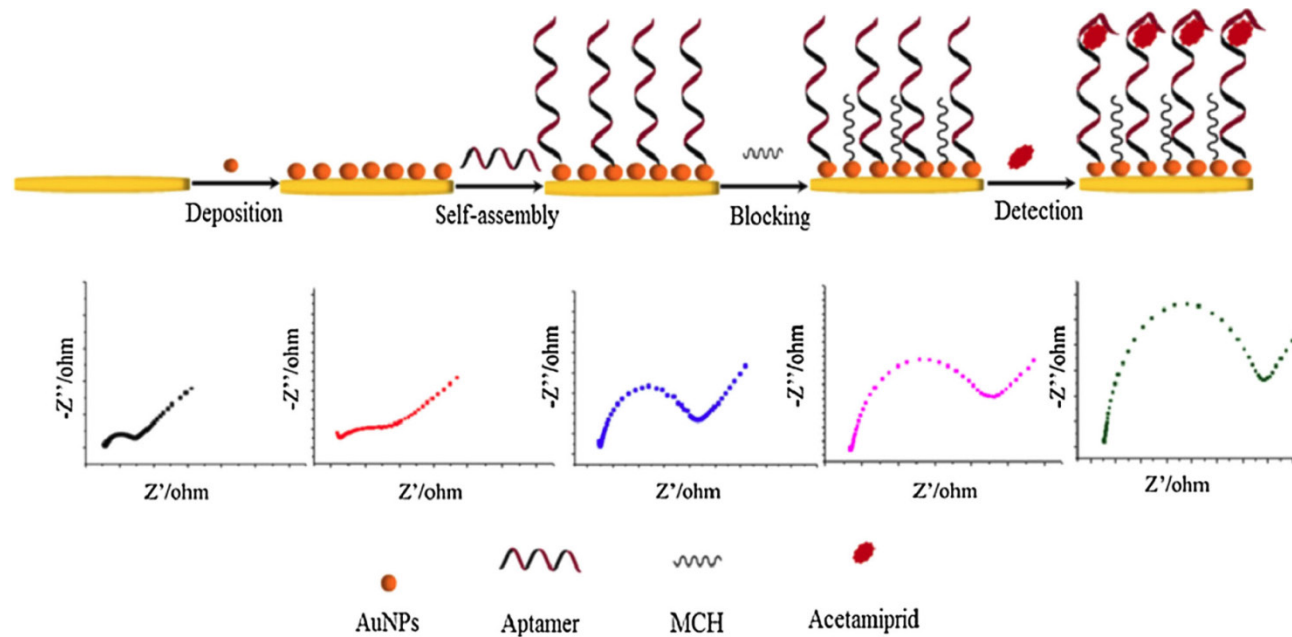

- Nyquist plots (impedance in ohm). The extent of the shift in EIS response (two final spectra) upon analyte binding, is a function of the analyte concentration. [See also Bode plots.]

a) Gencoglu, A and Adrienne R. Minerick . Electrochemical detection techniques in micro- and nanofluidic devices. *Microfluid Nanofluid* (2014) 17:781–807

b) Fan L, Zhao G, Shi H, Liu M, Li Z (2013) A highly selective electrochemical impedance spectroscopy-based aptasensor for sensitive detection of acetamidiprid. *Biosens Bioelectron* 43:12–18. doi:10.1016/j.bios.2012.11.033

Example: Cancer Marker Detection – Acimovic et. al.

Gold Nanorod Array

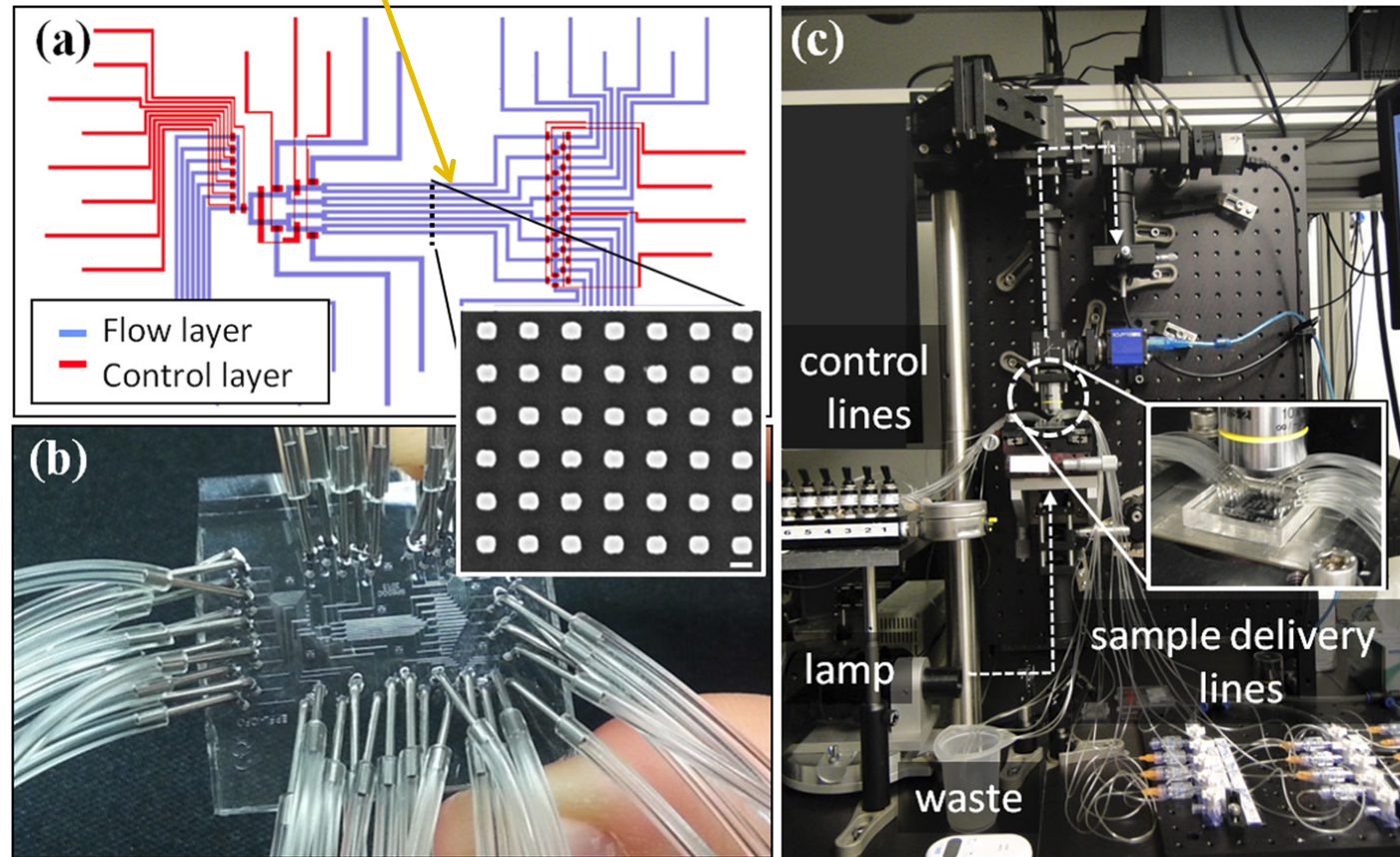

Detection of AFP and PSA Markers

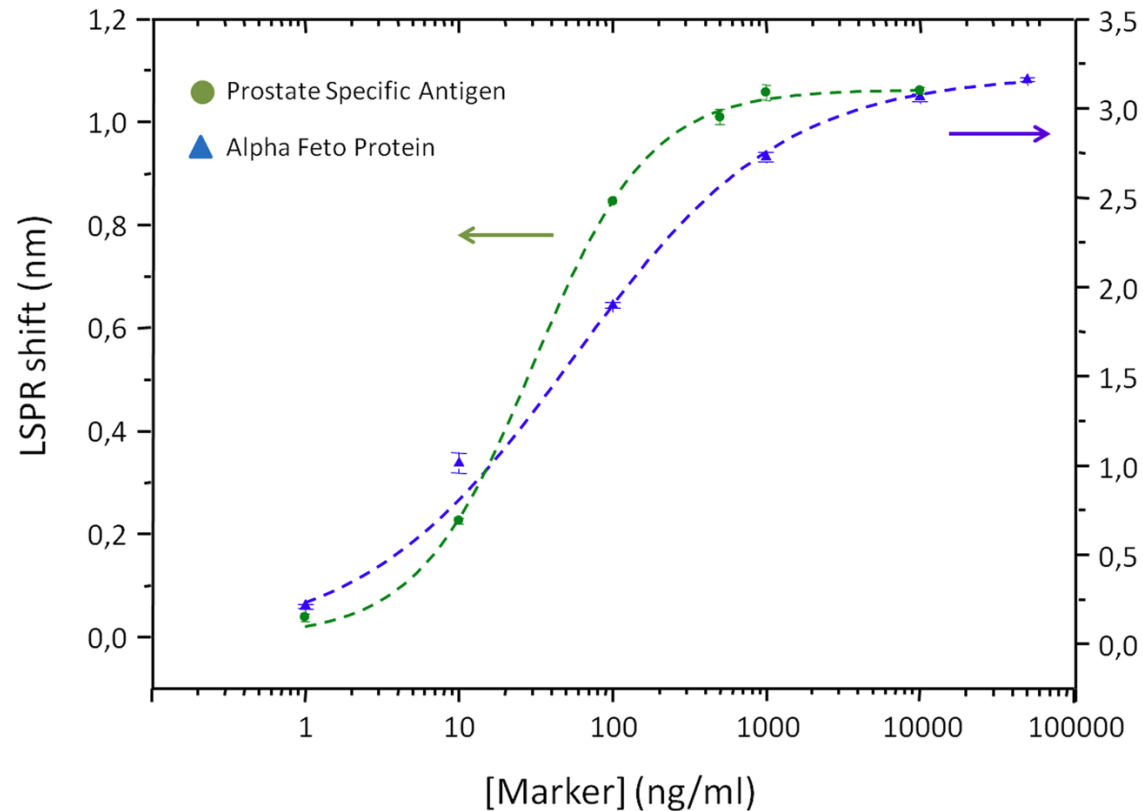

Parallel biosensor chip (LSPR response) for the detection of AFP and PSA cancer markers in 50% human serum.

Table of Chemiluminescence Detection

Optical Detection	Sensor Technology	Analyte	Assay Type	Time of Analysis	Resolution	Point of Care ^a	Ref.
Chemiluminescence	Microplate reader	Hepatitis B antigen	Capillary immunoassay	25 min	0.3 ng/mL	+	[52]
Chemiluminescence	PMT	Carcinoembryonic antigen	Sandwich immunoassay	-	20 pg/mL	+	[53]
Chemiluminescence	CCD camera	Staphylococcal enterotoxin B	Sandwich immunoassay	>60 min	0.1 ng/mL	+	[54]
Chemiluminescence	Inorganic photodiodes	Anti-HRP antibody	HRP-luminol reactions	>60 min	0.2 amol	++	[55]
Chemiluminescence	Inorganic photoconductor	Streptavidin	HRP-luminol reactions	Real time	4.76 nM	++	[56]
Chemiluminescence	Organic photodiodes	Staphylococcal enterotoxin B	Sandwich immunoassay	60–70 s	0.5 ng/mL	+++	[57]

- 52. Xiang, A.; Wei, F.; Lei, X.; Liu, Y.; Liu, Y.; Guo, Y. A simple and rapid capillary chemiluminescence immunoassay for quantitatively detecting human serum HBsAg. *Eur. J. Clin. Microbiol. Infect. Dis.* **2013**, *32*, 1557–1564.
- 53. Hao, M.; Ma, Z. An ultrasensitive chemiluminescence biosensor for carcinoembryonic antigen based on autocatalytic enlargement of immunogold nanoprobles. *Sensors* **2012**, *12*, 17320–17329.
- 54. Yang, M.; Sun, S.; Kostov, Y.; Rasooly, A. An automated point-of-care system for immunodetection of staphylococcal enterotoxin B. *Anal. Biochem.* **2011**, *416*, 74–81.
- 55. Caputo, D.; de Cesare, G.; Dolci, L.S.; Mirasoli, M.; Nascetti, A.; Roda, A.; Scipinotti, R. Microfluidic chip with integrated a-Si:H photodiodes for chemiluminescence-based bioassays. *IEEE Sens. J.* **2013**, *13*, 2595–2602.
- 56. Lin, C.C.; Ko, F.H.; Chen, C.C.; Yang, Y.S.; Chang, F.C.; Wu, C.S. Miniaturized metal semiconductor metal photocurrent system for biomolecular sensing via chemiluminescence. *Electrophoresis* **2009**, *30*, 3189–3197.
- 57. Wojciechowski, J.R.; Shriver-Lake, L.C.; Yamaguchi, M.Y.; Füreder, E.; Pieler, R.; Schamesberger, M.; Winder, C.; Prall, H.J.; Sonnleitner, M.; Ligler, F.S. Organic photodiodes for biosensor miniaturization. *Anal. Chem.* **2009**, *81*, 3455–3461.

Table of Fluorescence Detection

Optical Detection	Sensor Technology	Analyte	Assay Type	Time of Analysis	Resolution	Point of Care ^a	Ref.
Fluorescence	CMOS image sensor	<i>Giardia Lamblia</i> cysts	Microscopy	~1 s	Focal plane of 0.8 μm	+	[41]
Fluorescence	CCD camera	Bacterial DNA	PCR	Real time	~50 CFU/mL ^b	+	[49]
Fluorescence	Inorganic photodiodes	17- β estradiol	Competitive aptamer assay	~10 min	0.6 ng/mL	++	[50]
Fluorescence	Organic photodiodes	Alkylphenol polyethoxylates	Competitive immunoassay	~5 min	2–4 ppb	++	[51]

- 41. Lee, L.M.; Cui, X.; Yang, C. The application of on-chip optofluidic microscopy for imaging *Giardia lamblia* trophozoites and cysts. *Biomed. Microdevices* **2009**, *11*, 951–958.
- 49. Ramalingam, N.; Rui, Z.; Liu, H.B.; Dai, C.C.; Kaushik, R.; Ratnaharika, B.M; Gong, H.Q. Real-time PCR-based microfluidic array chip for simultaneous detection of multiple waterborne pathogens. *Sens. Actuators B Chem.* **2010**, *145*, 543–552.
- 50. Yildirim, N.; Long, F.; Gao, C.; He, M.; Shi, H.C.; Gu, A.Z. Aptamer-based optical biosensor for rapid and sensitive detection of 17 β -estradiol in water samples. *Environ. Sci. Technol.* **2012**, *46*, 3288–3294.
- 51. Ishimatsu, R.; Naruse, A.; Liu, R.; Nakano, K.; Yahiro, M.; Adachi, C.; Imato, T. An organic thin film photodiode as a portable photodetector for the detection of alkylphenol polyethoxylates by a flow fluorescence-immunoassay on magnetic microbeads in a microchannel. *Talanta* **2013**, *117*, 139–145.

SPR Sensing Approach

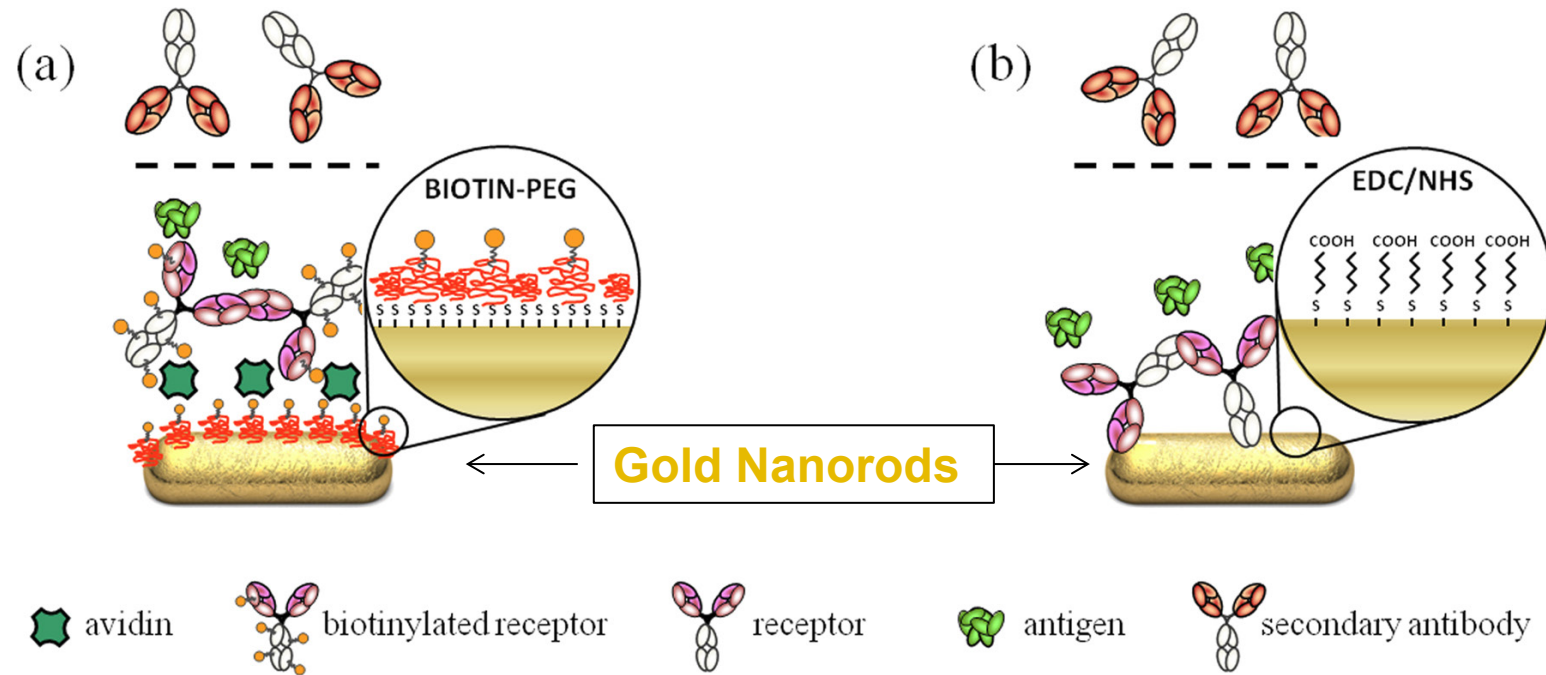

Schematic of the sensing approaches used for the detection of the analyte of interest where :

- a) A biotin-avidin is used to link the receptor.
- b) Carbodiimide chemistry is used.

Recall Interferometry...

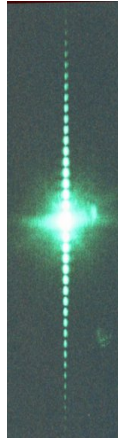
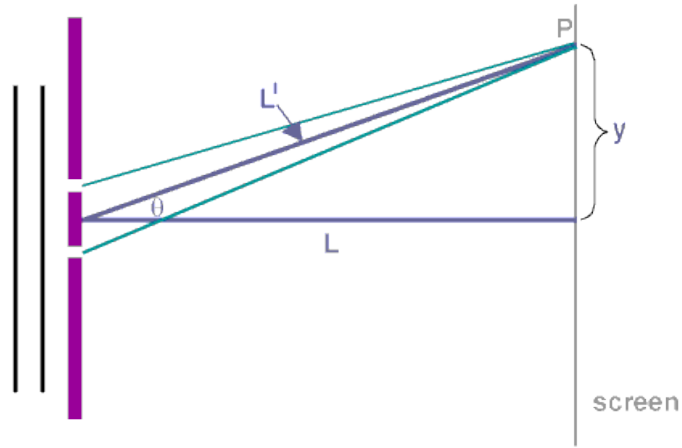

Young's Double Slit Interferometer

An interference pattern produced by two ideal slits.

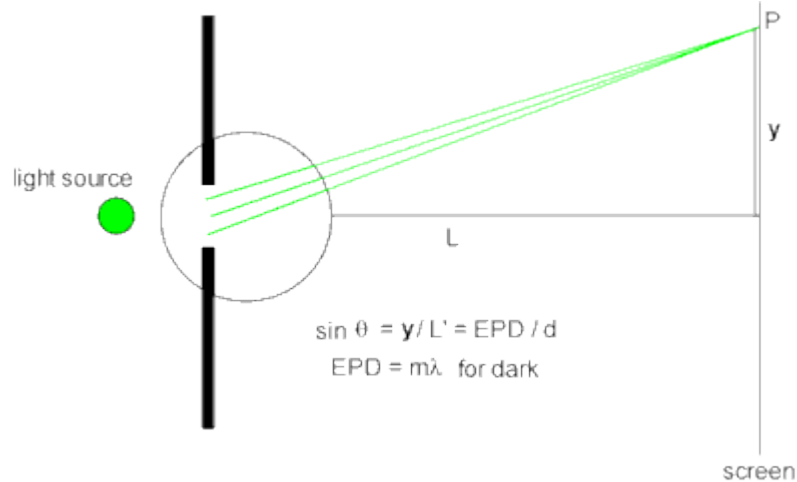
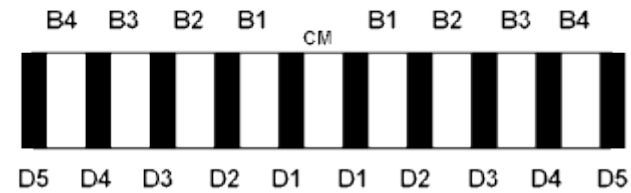

Diffraction

An interference pattern caused by diffraction through a single slit.

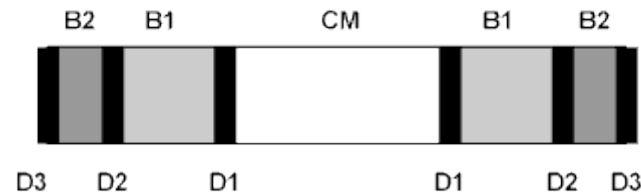

Mach-Zehnder Interferometer (MZI)

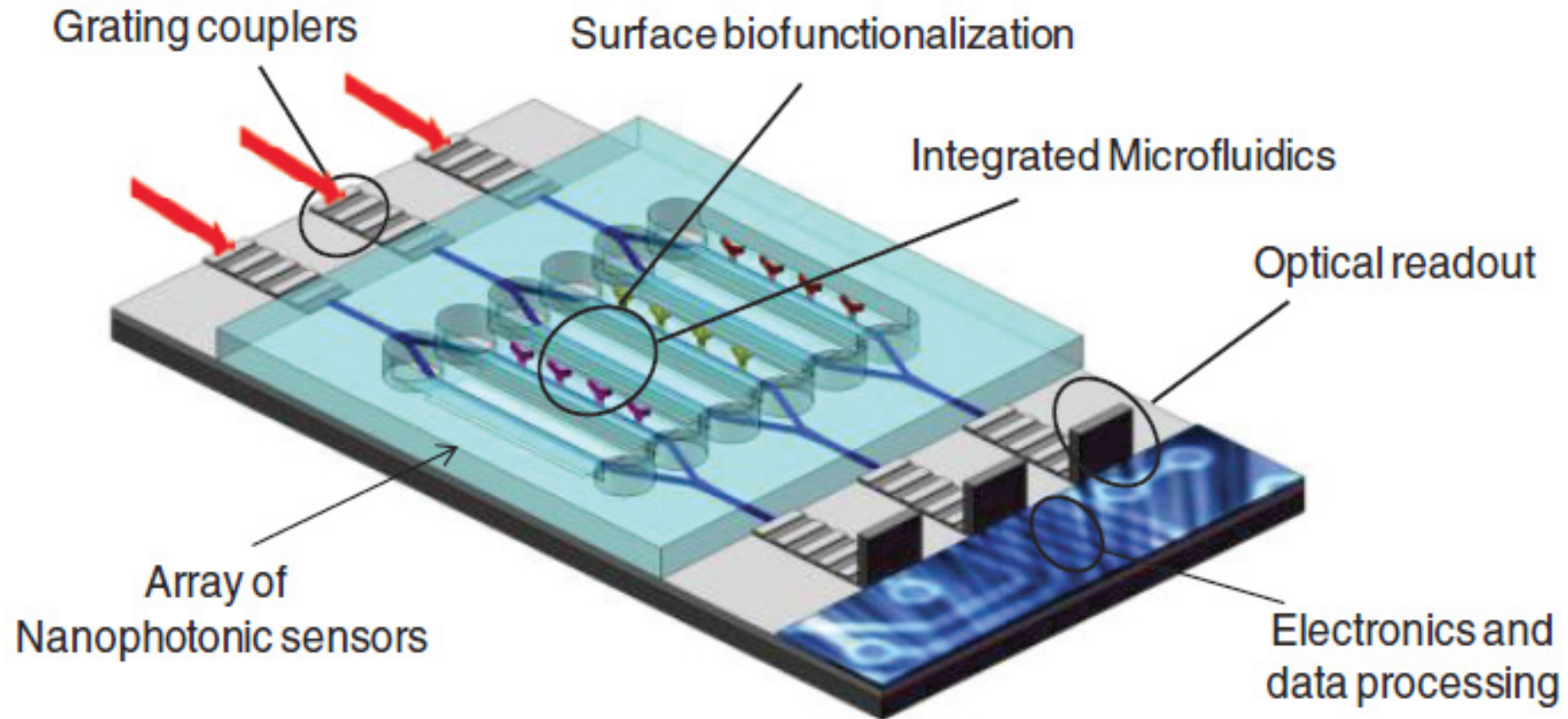

Gonzalez-Guerrero, A. B., et al. 2011. Advanced photonic biosensors for point-of-care diagnostics. *Euroensors Xxv* 25,

Digital In-Line Holographic Microscope

