

Introduction to BioMEMS & Medical Microdevices

Microsensors - MEMS

Prof. Steven S. Saliterman, <http://saliterman.umn.edu/>

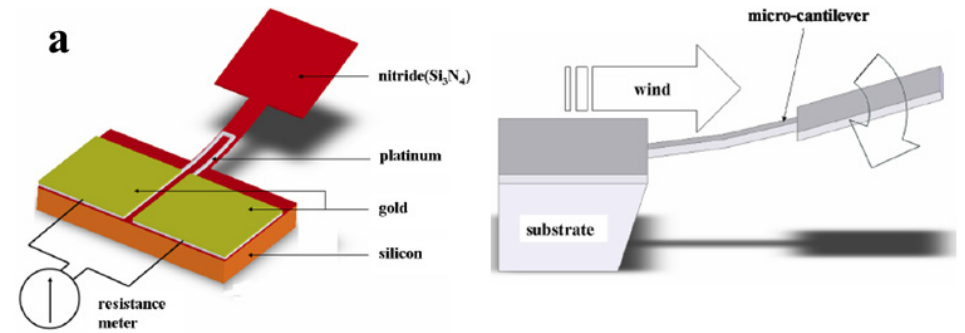
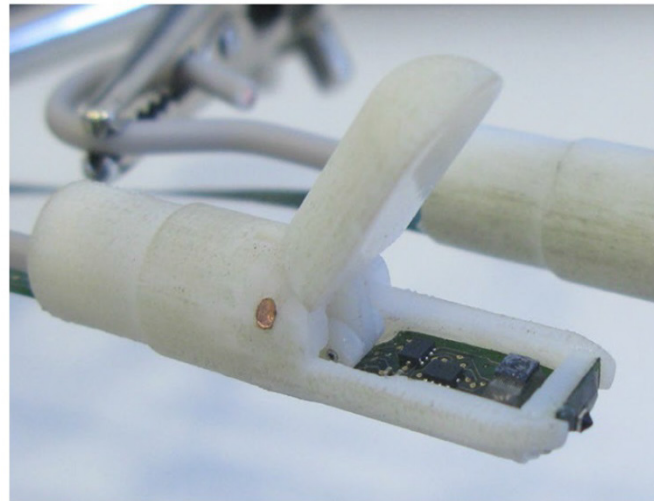
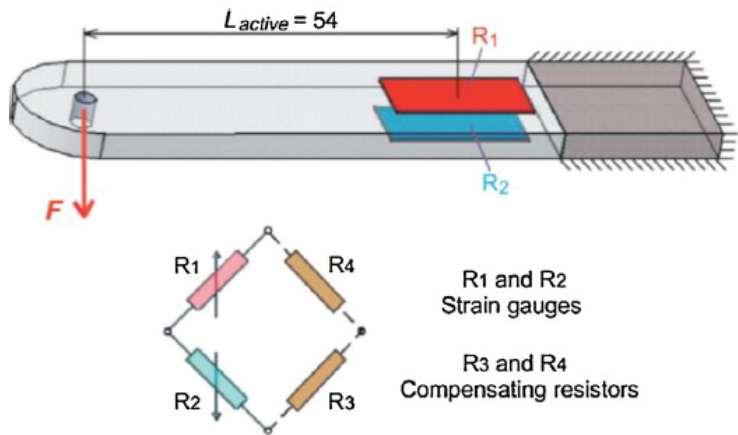

Common Microsensor Types

- **Thermal sensors** – measuring changes in temperature.
 - Thermomechanical
 - Thermoresistive
 - Thermocouples.
- **Mechanical sensors** – properties of strain, force and displacement.
 - Piezoresistive – strain in a semiconductor changes resistivity.
 - Piezoelectric – strain in a piezoelectric crystal causes a potential.
 - Capacitive – electrostatic, parallel plates and displacement.
 - Resonant – microfabricated beams and bridges.
- **Chemical sensors** – interaction with solids, liquids and gases.
- **Radiant sensors** – ionizing radiation, and visible, infrared or UV light.
- **Biosensors** - *measurement of biological analytes (previous lecture).*

The Ubiquitous Wheatstone Bridge

Quarter-bridge strain gauge circuit

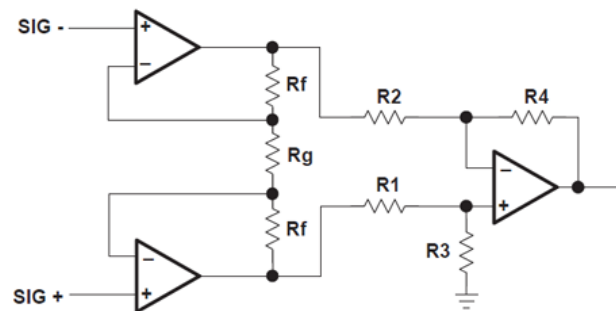
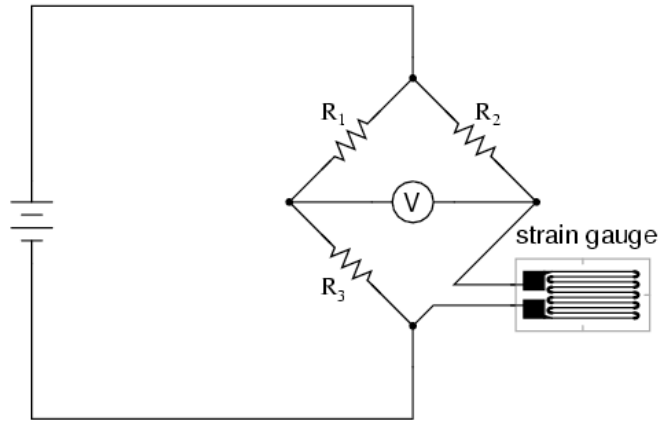

$$V_O = [(Sig +) - (Sig -)] \times \left[\frac{R_4}{R_2} \times \left[\frac{2R_f}{R_g} + 1 \right] \right]$$

R1=R2 and R3=R4

- If the bridge resistors have the same value, equal to the strain gauge's resistance at rest, then the voltage is zero.
- The voltage can be amplified to get a higher sensitivity for the complete circuit.
- This can be done with a high gain instrumentation amplifier
- The instrumentation amplifier inputs replace the volt meter in the top circuit.

Strain Gage...

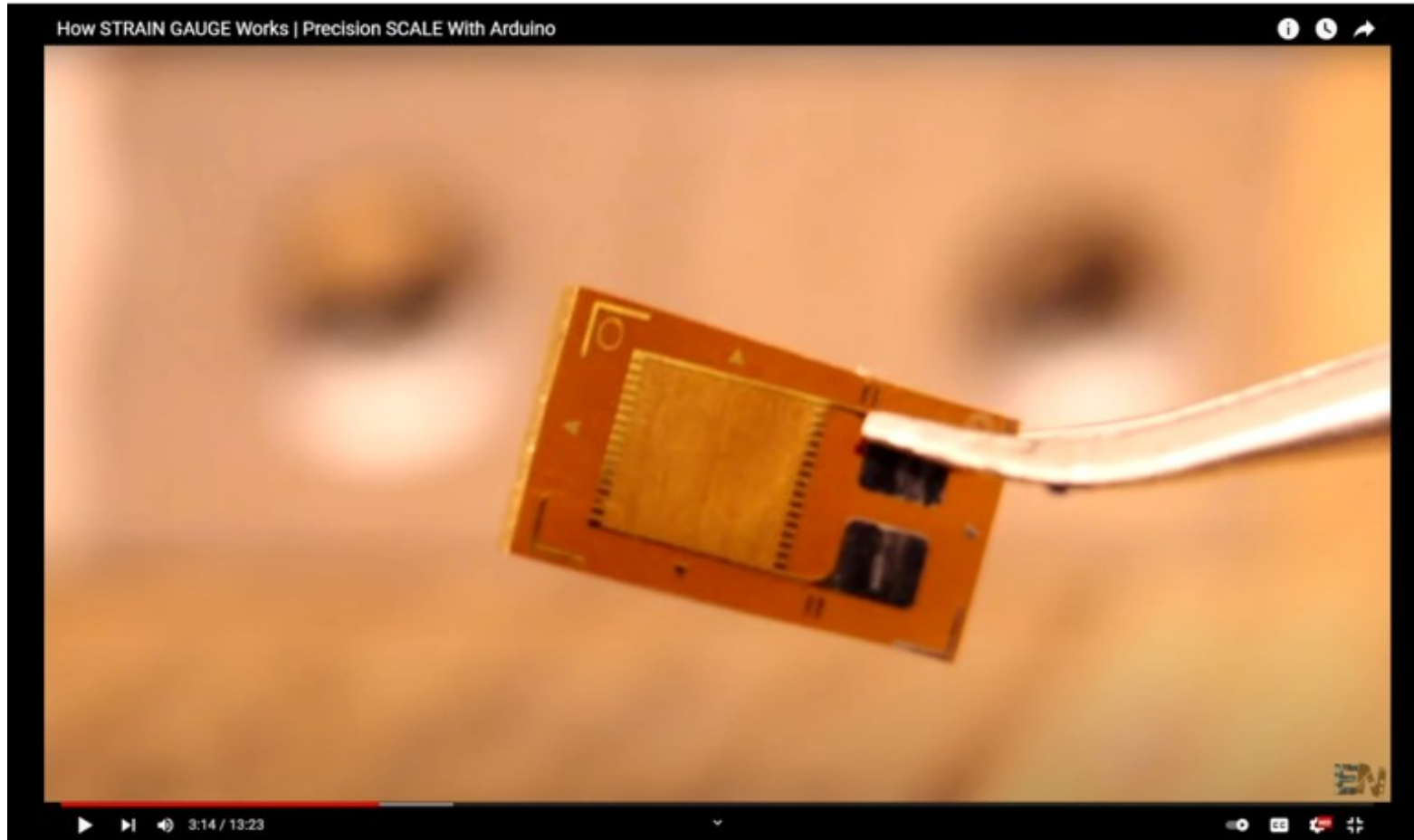

Piezoelectric Effects

- Transduction from mechanical to electrical domains and vice versa. May be used as sensors or actuators.
- A reversible and linear piezoelectric effect:
 - **Converse:** production of a strain (stress) upon application of an electric field.
 - **Direct:** production of a charge (voltage) upon application of stress.
- Three modes of operation depending on how the piezoelectric material is cut: **transverse**, **longitudinal** and **shear**.
- *Amplifiers are needed to detect the small voltage.*

Direct and Converse Piezoelectric Effects...

Converse Piezoelectric Effect - Application of an electrical field creates mechanical deformation in the crystal.

Poling - Random domains are aligned in a strong electric field at an elevated temperature.

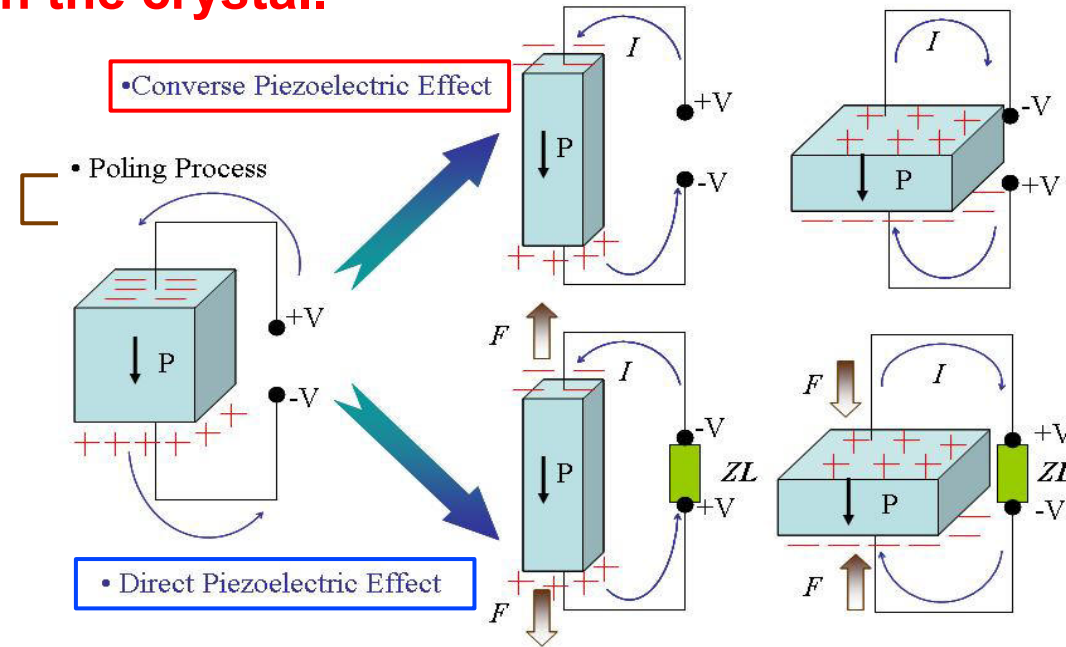

Direct Piezoelectric Effect - When a mechanical stress (compressive or tensile) is applied a voltage is generated across the material. Common in sensors.

Piezoelectricity...



Piezoelectric Relationship...

- The **piezoelectric effect** is a linear phenomenon where deformation is proportional to an electric field:

Converse Effect

$$S = dE$$

Direct Effect

$$D = dT$$

Know this!

Where

S is the mechanical strain,

d is the piezoelectric coefficient,

E is the electric field,

D is the displacement (or charge density) linearly, and

T is the stress.

Sensor Configurations...

- Piezoelectric sensors may be configured as direct mechanical transducers or as resonators (recall SAWs).
 - The observed resonance frequency and amplitude are determined by the physical dimensions, material and mechanical and interfacial inputs to the device.

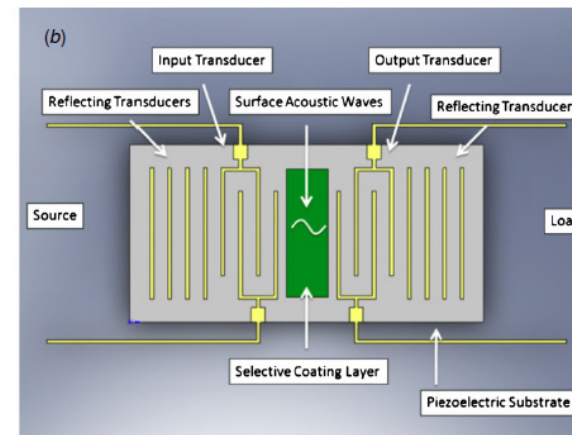
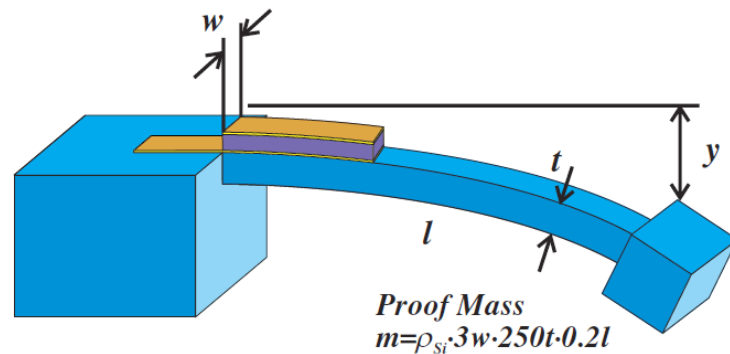

Approaches to Fabrication...

- Three approaches to realizing a piezoelectric MEMS devices:
 1. Deposition of piezoelectric thin films on silicon substrates with appropriate insulating and conducting layers followed by surface or silicon bulk micromachining to realize the micromachined transducer (“additive approach”).
 2. Direct bulk micromachining of single crystal or polycrystalline piezoelectrics and piezoceramics (“subtractive approach”).
 3. Integrate micromachined structures in silicon via bonding techniques onto bulk piezoelectric substrates (“integrative approach”).

Common Piezoelectric Materials...

1. Crystals

- Quartz SiO_2
- Berlinite AlPO_4
- Gallium
- Orthophosphate GaPO_4
- Tourmaline (complex chemical structure)

2. Ceramics

- Barium titanate BaTiO_3
- Lead zirconate titanate PZT, $\text{Pb} [\text{Zr}_x\text{Ti}_{1-x}] \text{O}_3$; $x = 0,52$

3. Other Materials

- Zinc oxide ZnO
- Aluminum nitride AlN
- Polyvinylidene fluoride PVDF

Micromachining a Piezoelectric Sensor...

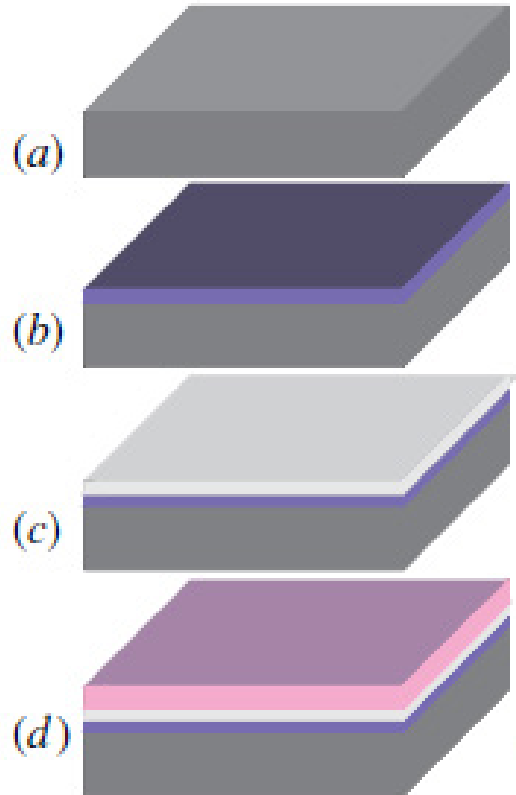

- a) Substrate silicon wafer.
- b) Thermal oxide placed.
- c) Bottom platinum electrode is deposited.
- d) The piezoelectric thin film is deposited and annealed.

Piezoelectric Sensor Continued...

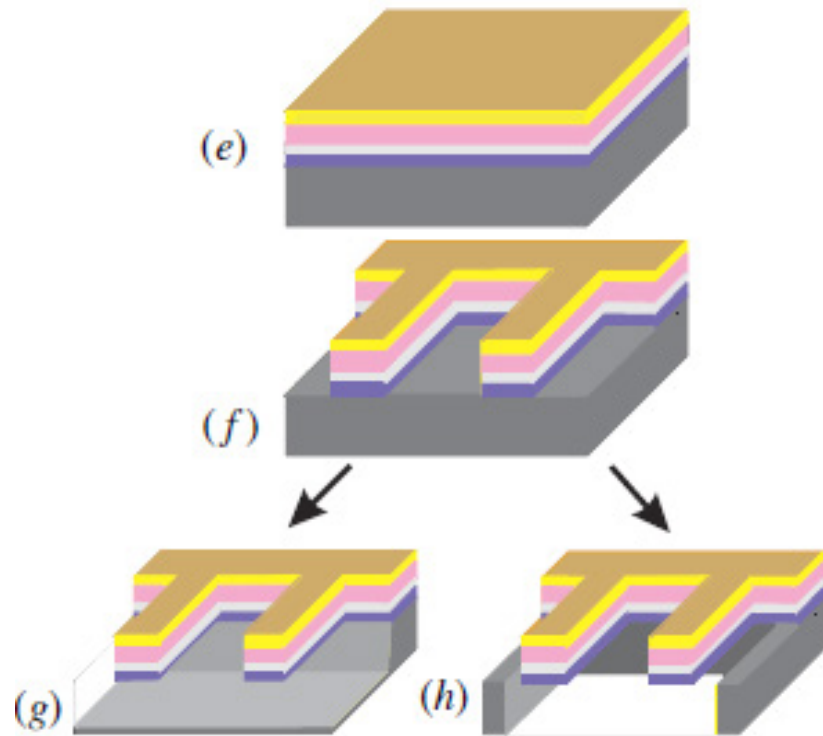

- e) Top electrode metal such as Cr/Au is deposited.
- f) The entire piezoelectric, electrodes and passive layer stack is patterned and etched.
- g) Substrate silicon is etched from the front side using anisotropic wet etchant or isotropic vapor phase XeF_2 etchant while protecting the transducer stack.
- h) *Alternatively, the substrate silicon is anisotropically etched from backside to release the transducer structure.*

Thermosensors

- Platinum resistor:
 - Linear, stable, reproducible.
 - Material property dependency on temperature,
- **Thermocouples (e.g. Type K)**
- Thermistor: a semiconductor device made of materials whose resistance varies as a function of temperature.
- **Thermodiode and Thermotransistor.**

Thermocouple...

- Potentiometric devices fabricated by the joining of two different metals forming a sensing junction:
 - Based on the thermoelectric *Seebeck effect* in which a temperature difference in a conductor or semiconductor creates an electric voltage:

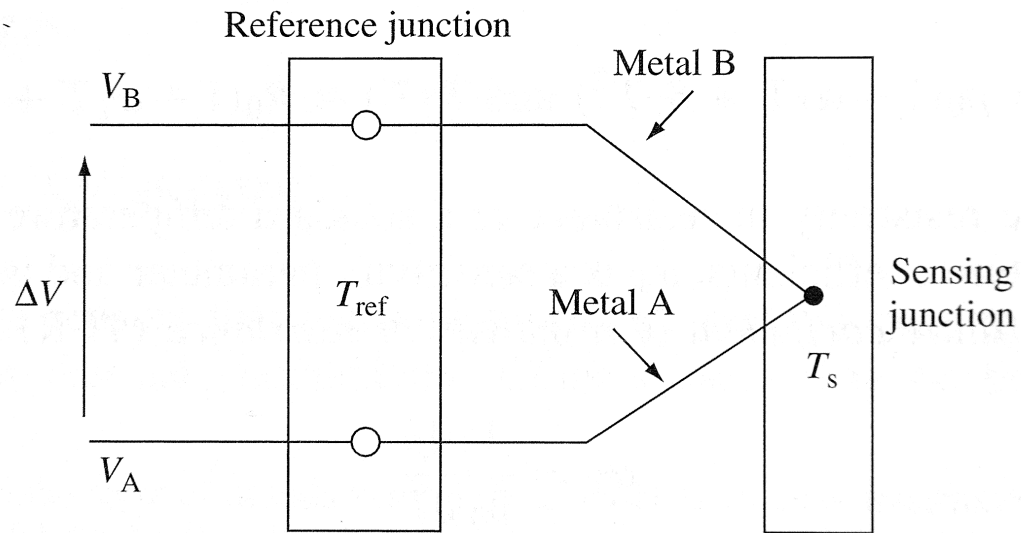

$$\Delta V = \alpha_s \Delta T$$

Where

ΔV is the electrical voltage,

α_s is the Seebeck coefficient expressed in volts/ K° , and

ΔT is the temperature difference ($T_s - T_{ref}$).

Know this!

Thermodiode and Thermotransistor...

- When a *p-n diode* is operated in a constant current (I_0) circuit, the forward voltage (V_{out}) is *directly proportional to the absolute temperature (PTAT)*.

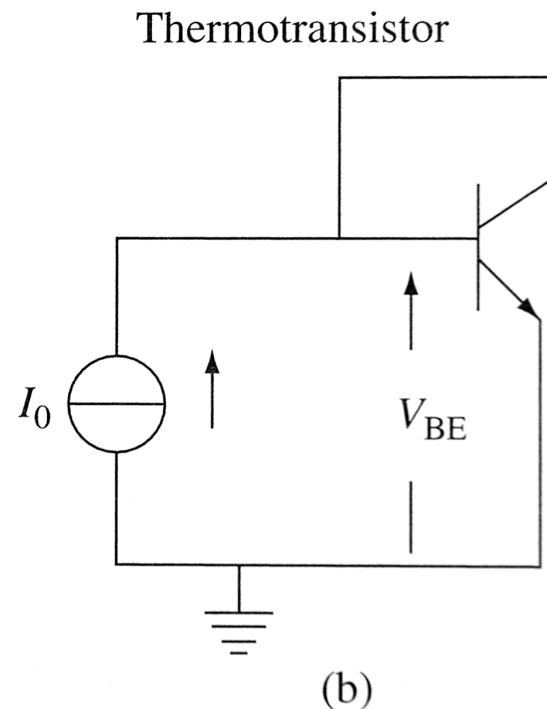
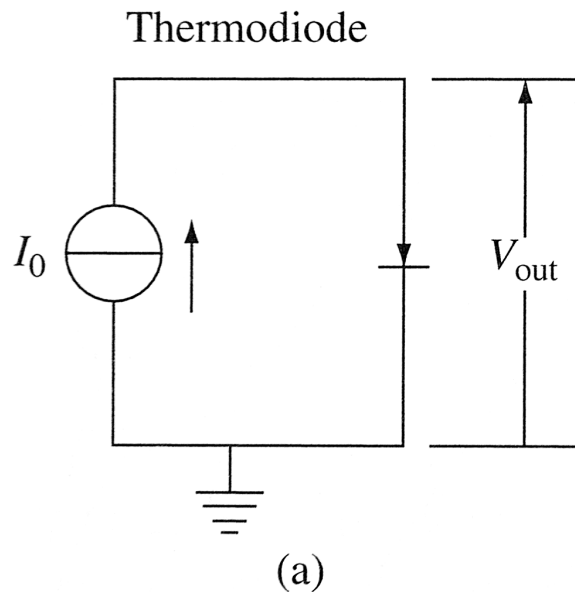

$$V_{out} = \frac{k_B T}{q} \ln \left(\frac{I}{I_S} + 1 \right)$$

Where

k_b is the Boltzman constant,

T is temperature,

q is the charge on an electron,

I is the operating current and

I_S is the saturation current.

Microforce Measurement

- Microforce sensing considerations:
 - Contact force feedback is essential for microassembly.
 - Forces may be in the micro-newton range.
 - Micromanipulation (handling micro-scale objects) – e.g. cells or capillaries.
 - Other micro-components are easily destroyed – e.g. microgrippers.
 - Alignment of micro-optical systems.

Methods...

- Force sensing methods (examples to follow):
 - Strain gauge-based force sensor.
 - Piezoresistive force sensor.
 - Capacitive force sensor.
 - Piezomagnetic force sensor.
- Others
 - Optical force sensor (Raman spectrometer, laser interferometer, AFM, optical tweezers).
 - Vision-based force sensor.
 - Electroactive force sensor (electronic and ionic).
 - PZT force sensor (based on direct piezoelectric effect).
 - PVDF force sensor (polyvinylidene difluoride).

Calculating Young's Modulus...

Stress

$$\sigma = \frac{F}{A}$$

Where...

σ stress (Mpa),

F is the force (N),

A is the cross-sectional area (mm²)

Strain

$$\epsilon = \frac{(L - L_0)}{L_0}$$

Where...

ϵ is the strain,

L is the stretched length,

L_0 is the initial length (mm)

Young's Modulus
(Stress/Strain)

$$E = \sigma / \epsilon$$

Know this!

Strain Gauge

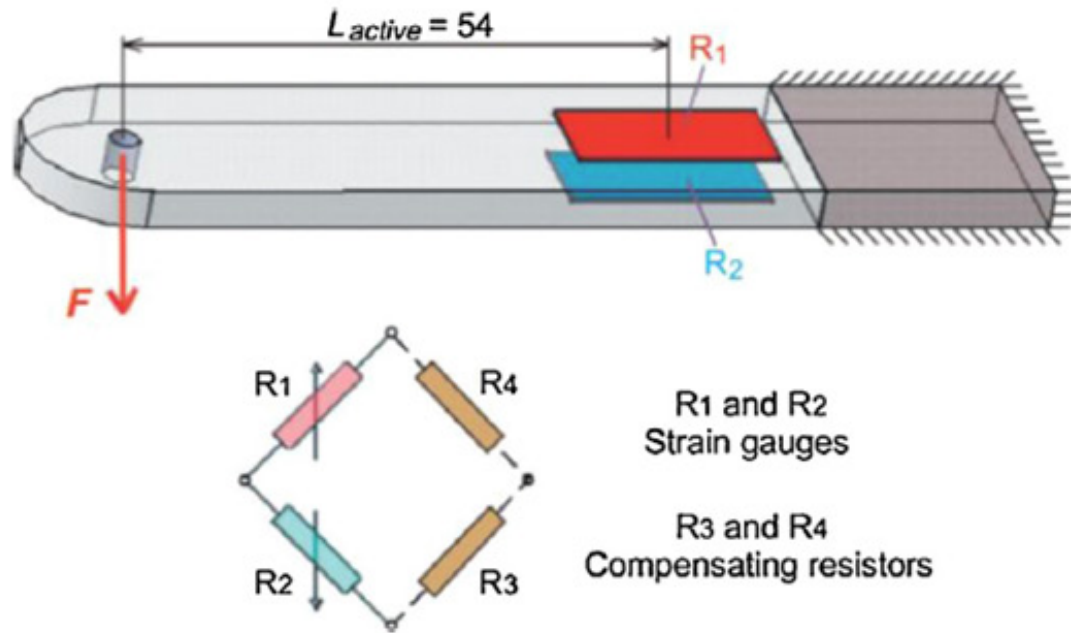

Applied force

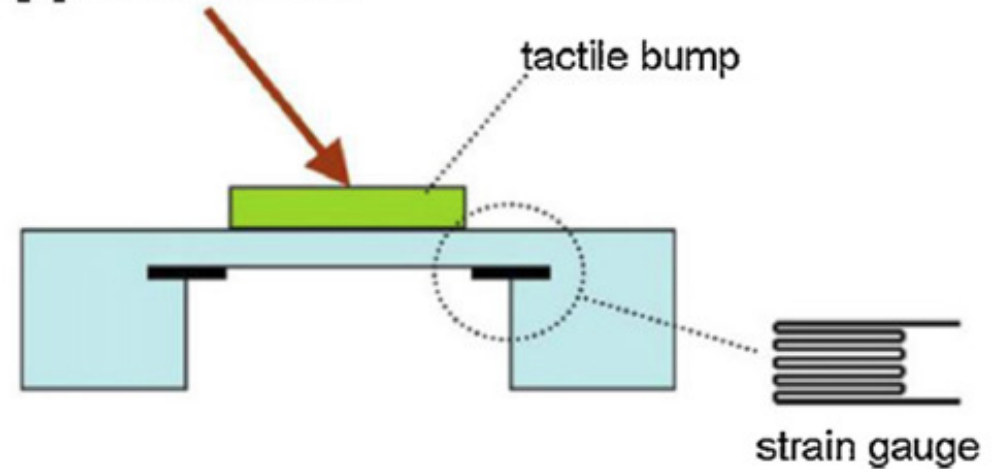
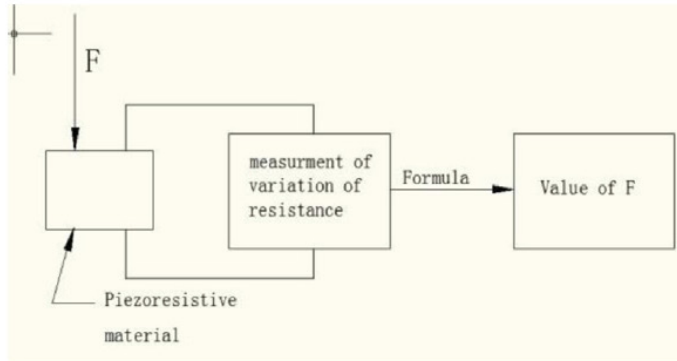

Fig. 3. An application of strain gauge-based force sensors [21].

- 1) C. Ma, J. Du, Y. Liu, Y. Chu, Overview of micro-force sensing methods, in: K.M. Lee, P. Yarlagadda, Y.M. Lu (Eds.), Progress In Mechatronics And Information Technology, 2015, Pts 1 And 22,014, 25–31.
- 2) D.M. Stefanescu, A.T. Farcasiu, A. Toader, Strain gauge force transducer and virtual instrumentation used in a measurement system for retention forces of palatal plates or removable dentures, Sens. J. IEEE 12 (2012) 2968–2973.
- 3) H. Yousef, M. Boukallel, K. Althoefer, Tactile sensing for dexterous in-hand manipulation in robotics—a review, Sens. Actuators A: Phys. 167 (2011) 171–187.

Piezoresistive Sensor...



(a)

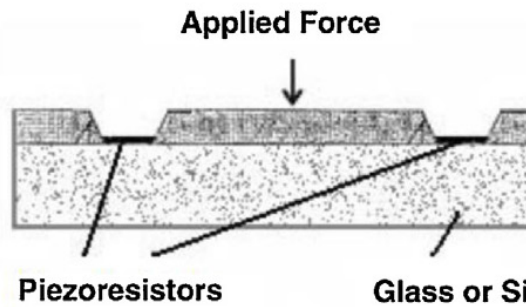

(b)

$$\frac{\Delta R_s}{R_s} = G_f \times \frac{\Delta L}{L}$$

Where...

G_f is strain,

ΔR_s and ΔL are resistance and length before deformation.

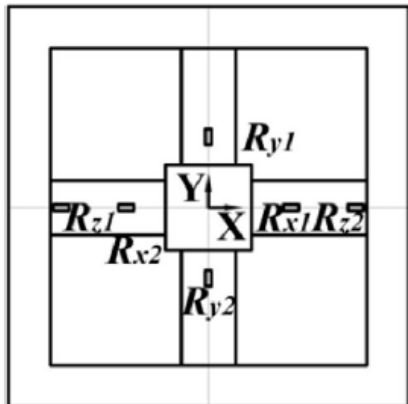

(a)

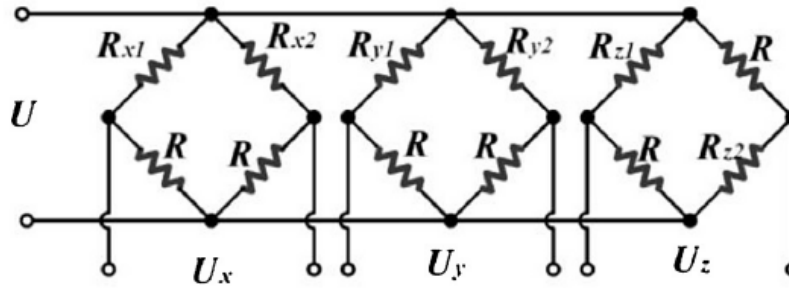

(b)

- Most common technique for measuring microforce.
- When a metal or semiconductor material is under stress, its resistance will change proportionally to its deformation.
- Wheatstone bridge can be used to translate variation in resistance to voltage.

Making a PDMS Stamp & Carbon Particle Sensor...

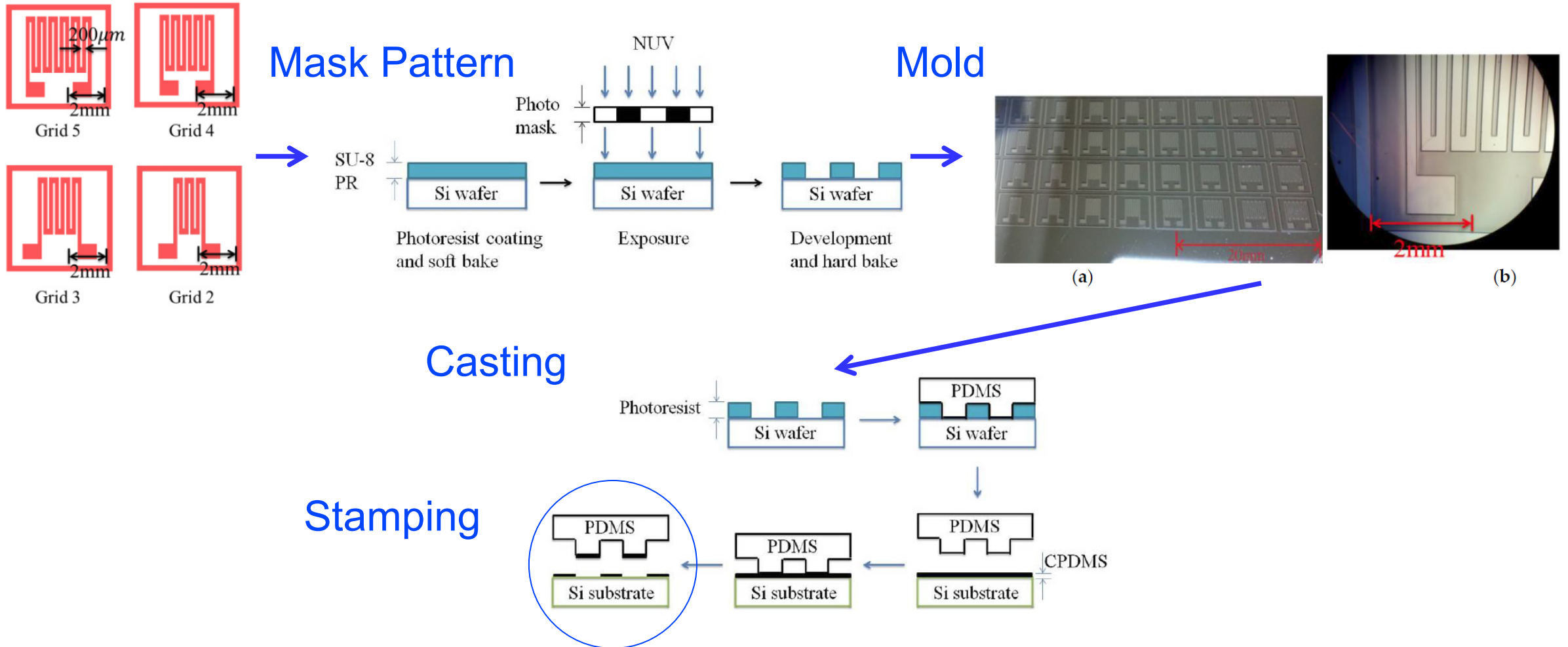

Han CJ, Chiang HP, Cheng YC. Using Micro-Molding and Stamping to Fabricate Conductive Polydimethylsiloxane-Based Flexible High-Sensitivity Strain Gauges. *Sensors*. 2018;18(2).

Testing...

Compression

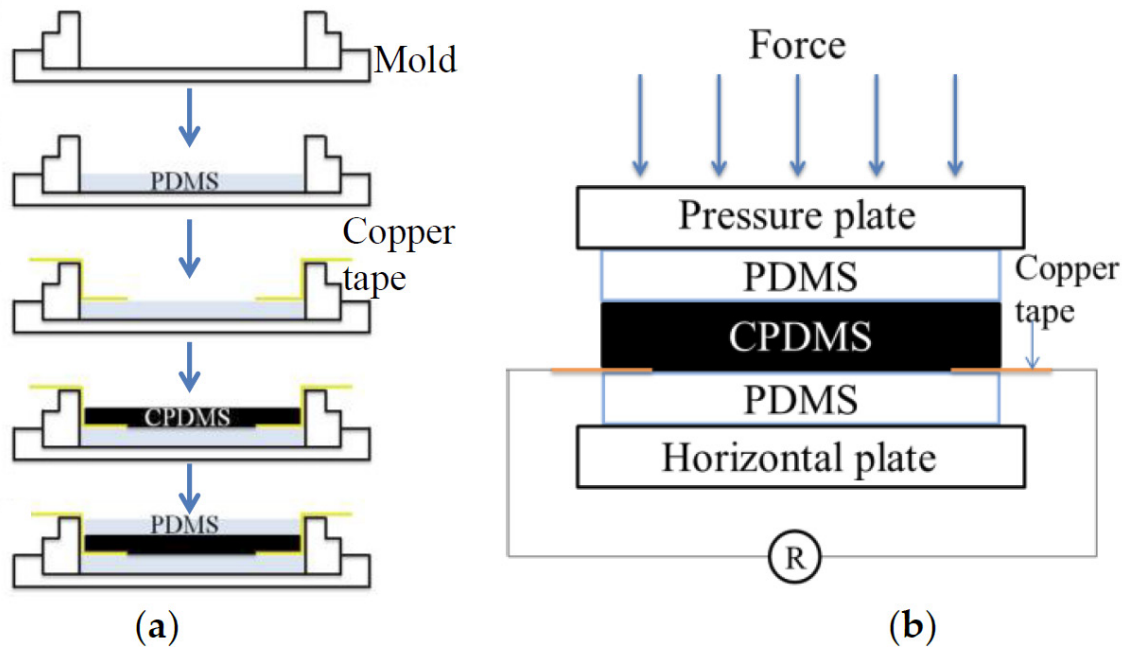

Piezoresistance measurement.

Stretching

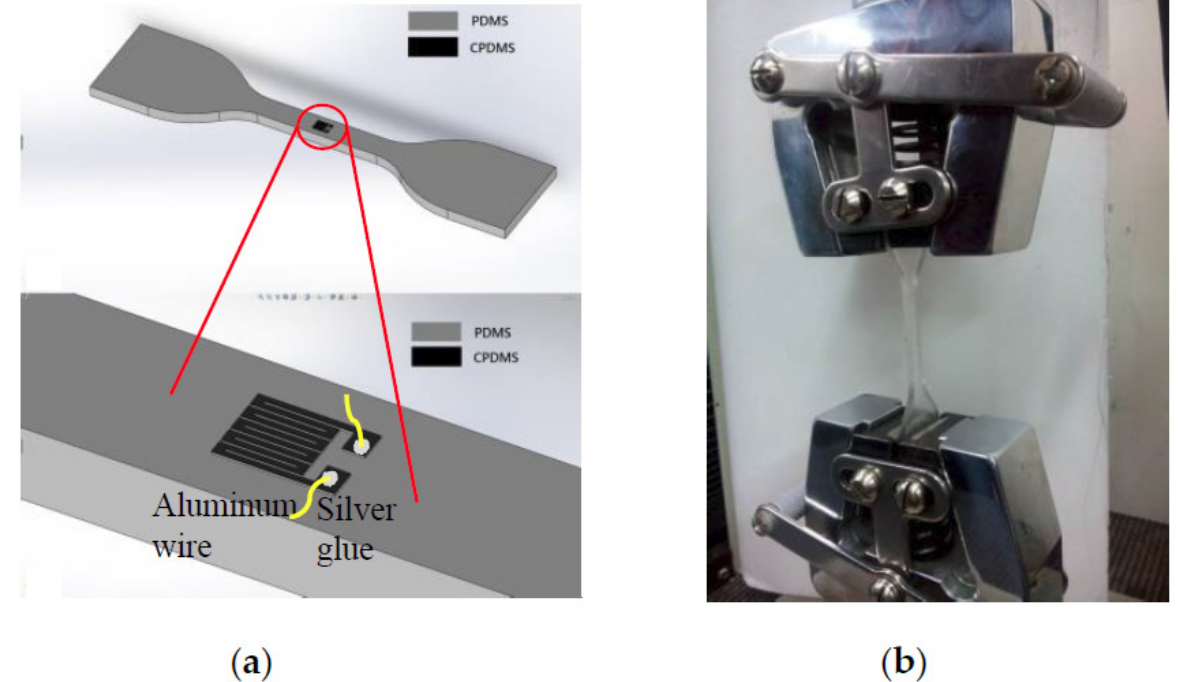

Piezoresistance measurement of the strain gauge with the CPDMS attached on the strain gauge.

Results...

a) Resistance increased with applied pressure.

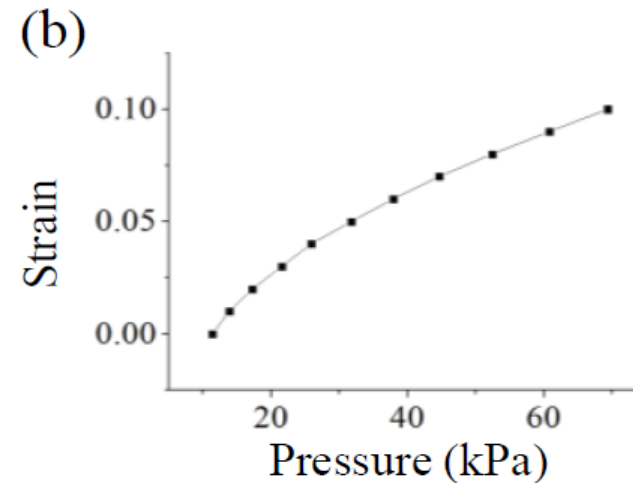
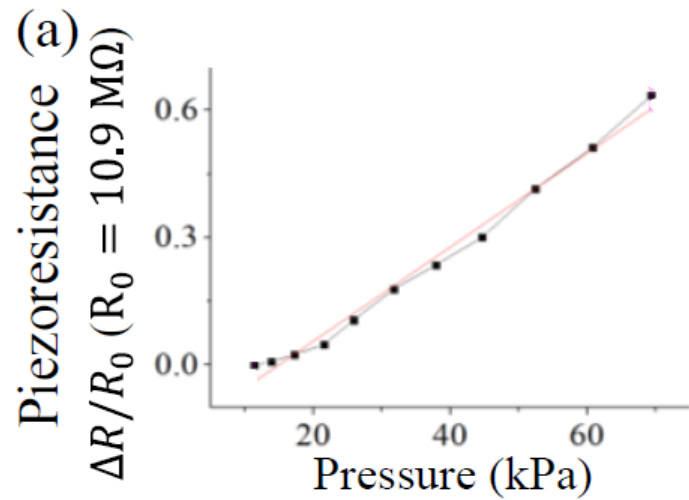

b) Ratio of pressure and strain.

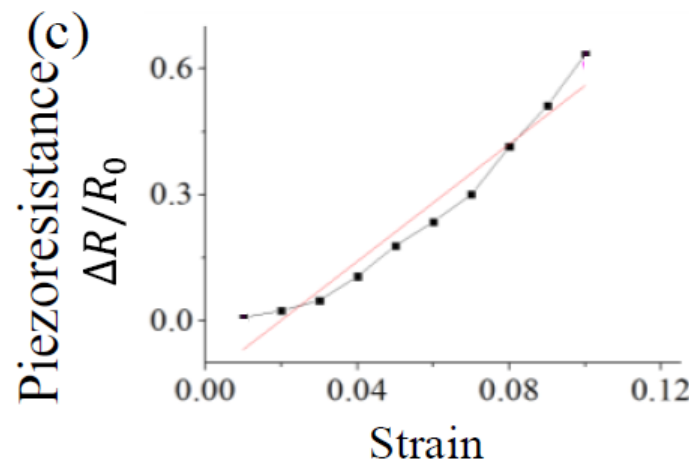

c) Piezoresistance to strain.

Sensor for Laparoscopic Surgery...

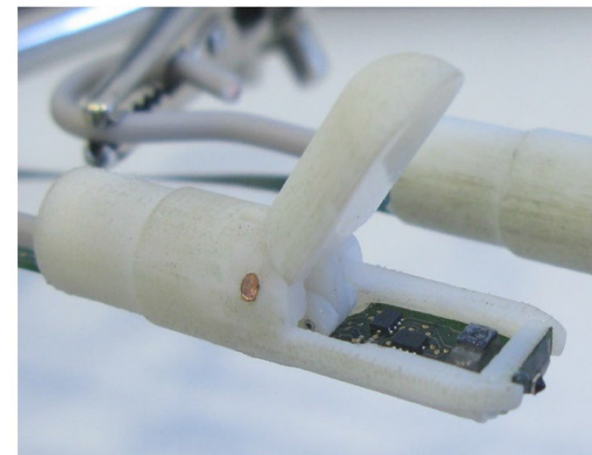
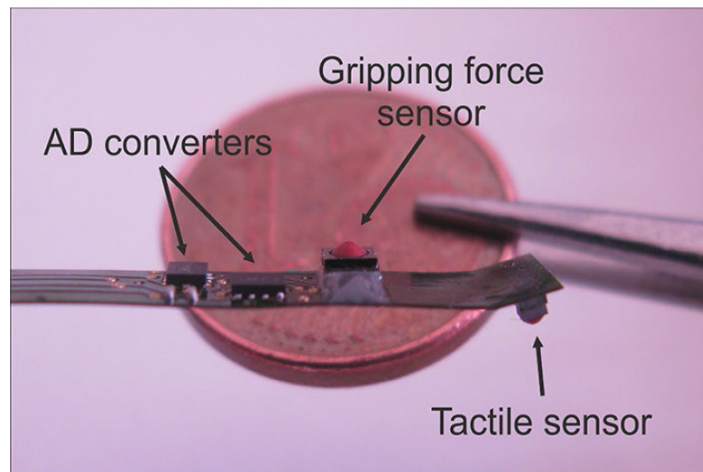
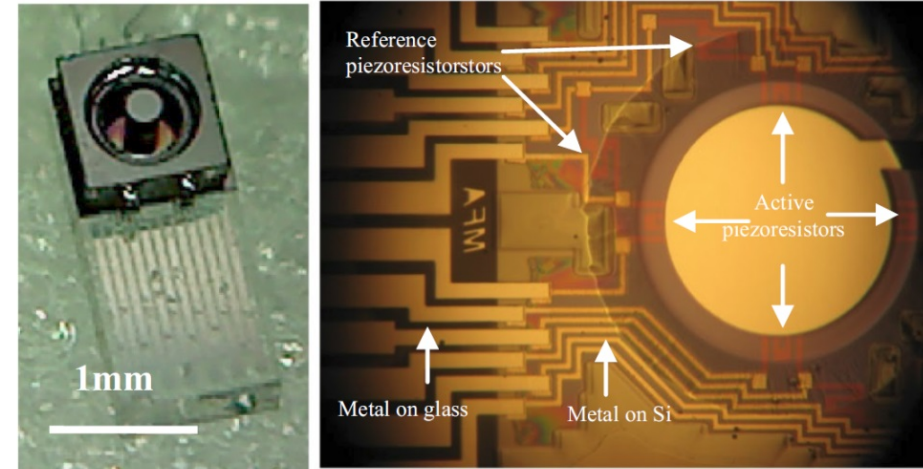

Rado J, Ducso C, Foldesy P, et al. 3D force sensors for laparoscopic surgery tool. *Microsystem Technologies-Micro-and Nanosystems-Information Storage and Processing Systems*. 2018;24(1):519-525.

Capacitive Force Sensor

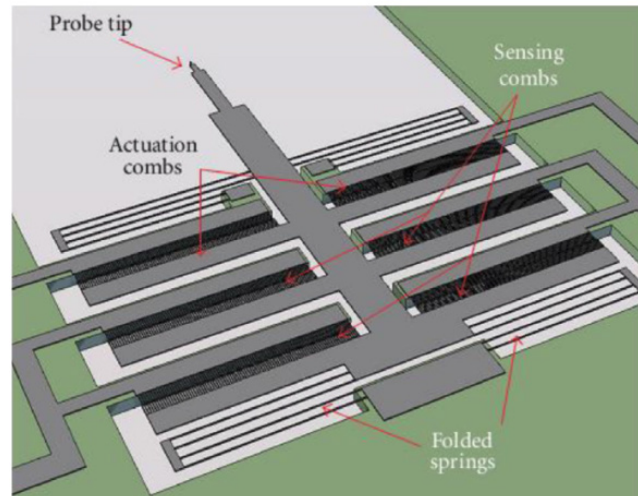
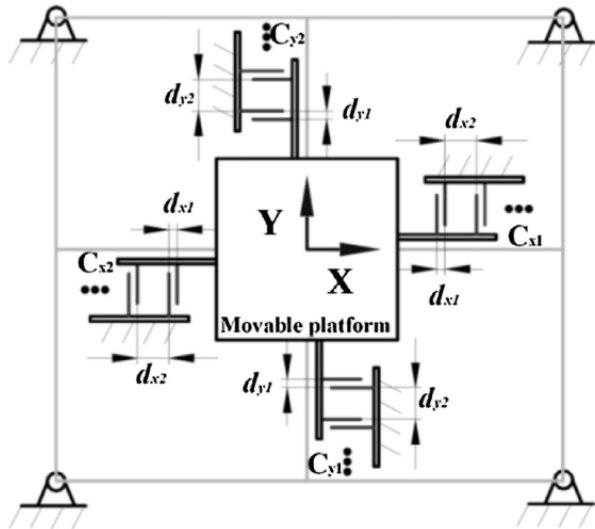
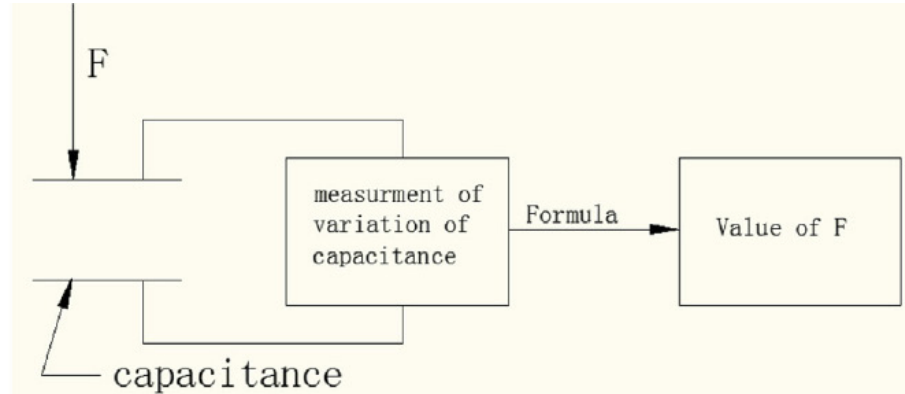
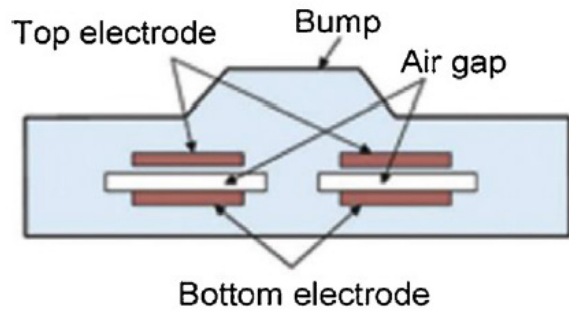

- Functions by measuring force by changes in the distance between plates.
- Able to measure normal and shear stress.
- Range: mN to pN.
- RC circuits may account for up to 30% of sensors.
- Signals are obtained by capacitance to frequency conversion (oscillator), switched capacitor or capacitive AC bridge circuits.

H. Yousef, M. Boukallel, K. Althoefer, Tactile sensing for dexterous in-hand manipulation in robotics—a review, *Sens. Actuators A: Phys.* 167 (2011) 171–187.
S. Nadvi, D.P. Butler, Z. Celik-Butler, I.E. Goenenli, Micromachined force sensors using thin film nickel-chromium piezoresistors, *J. Micromech. Microeng.* 22 (2012).
L. Zhang, J. Dong, Design, fabrication, and testing of a SOI-MEMS-Based active microprobe for potential cellular force sensing applications, *Adv. Mech. Eng.* (2012).

Piezomagnetic Force Sensor

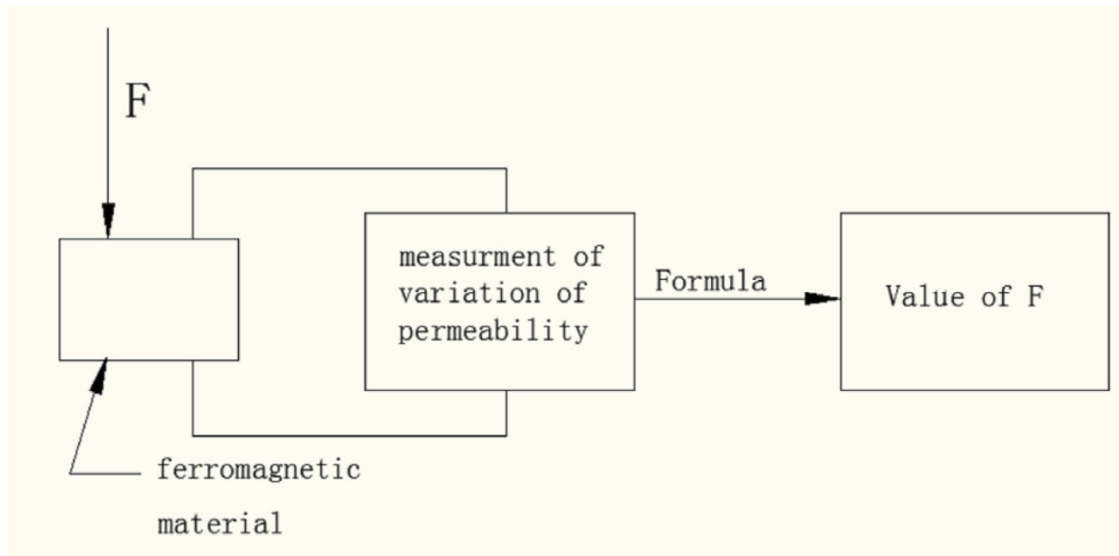

- **Magnetoelastic effect** - when a ferromagnetic material subjects to mechanical stress, its internal strain leads to the changes in permeability.
- Dynamic and static force measurements.
- Does not need to be glued to the surface.

Steven S. Saliterman

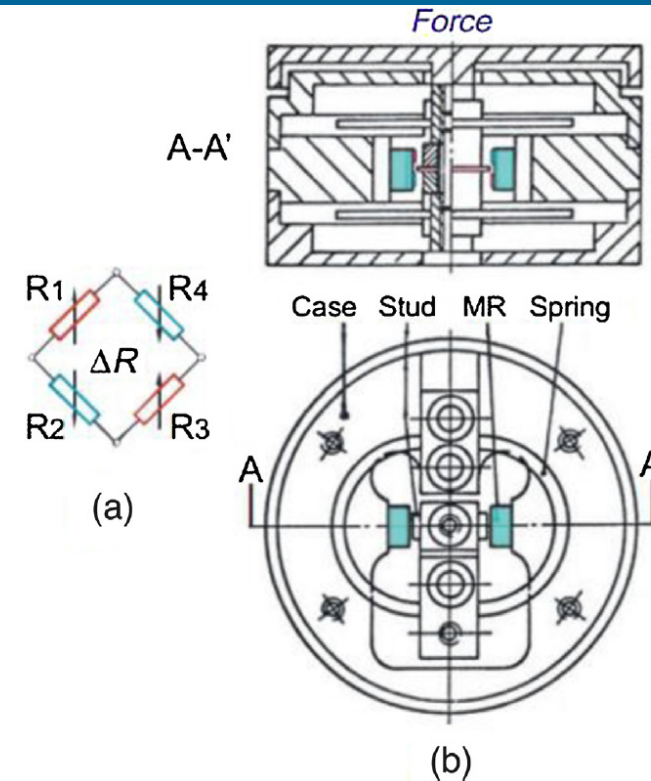

Wheatstone bridge configuration with magnetoresistive sensors. Resistance varies with magnetic field strength.

Flow Sensors

- Measurement of gas and liquid flow rates.
- May be integrated with microfluidics.
- Useful for blood and urine flow, respiratory monitoring and drug delivery devices.
- Advantages of high sensitivity, accuracy and precision, low power consumption and small size.
- Broadly categorized as thermal (thermal exchange) and non-thermal flow sensors.

Thermal Flow Sensing...

1. **Hot wire or hot element anemometers.**
 - Based on **convective heat exchange** taking place when the fluid flow passes over the sensing element (hot body).
 - Operate in constant temperature mode or in constant current mode.
2. **Calorimetric sensors.**
 - Based on the monitoring of the **asymmetry of temperature profile around the hot body** which is modulated by the fluid flow.

Example of a Thermal Flow Sensor...

- The heat transferred per unit time from a resistive wire heater to a moving liquid is monitored with a thermocouple:

Steady state, the mass flow rate

$$Q_m = \frac{dm}{dt} = \frac{P_h}{c_m} (T_2 - T_1)$$

Where

Q_m is the mass flow rate,

P_h is the heat transferred per unit time,

c_m is the specific heat capacity of the fluid and

T_1, T_2 are temperature.

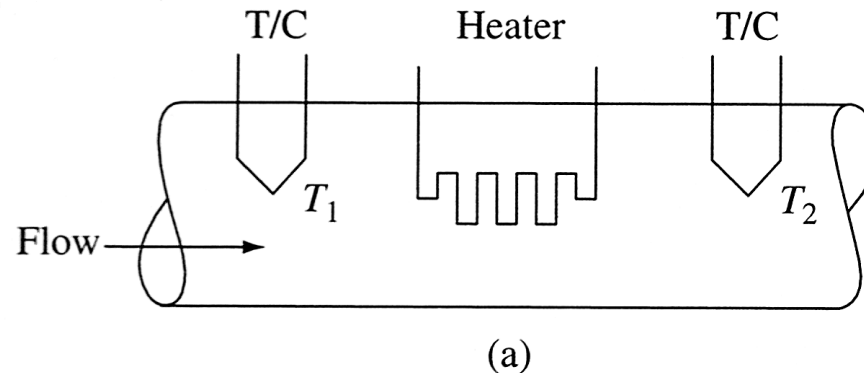

The volumetric flow rate

$$Q_V = \frac{dV}{dt} = \frac{Q_m}{\rho_m}$$

Where

Q_V is the volumetric flow rate,

Q_m is the mass flow rate and

ρ_m is the density.

Thermal Flow Sensor with Thermopile...

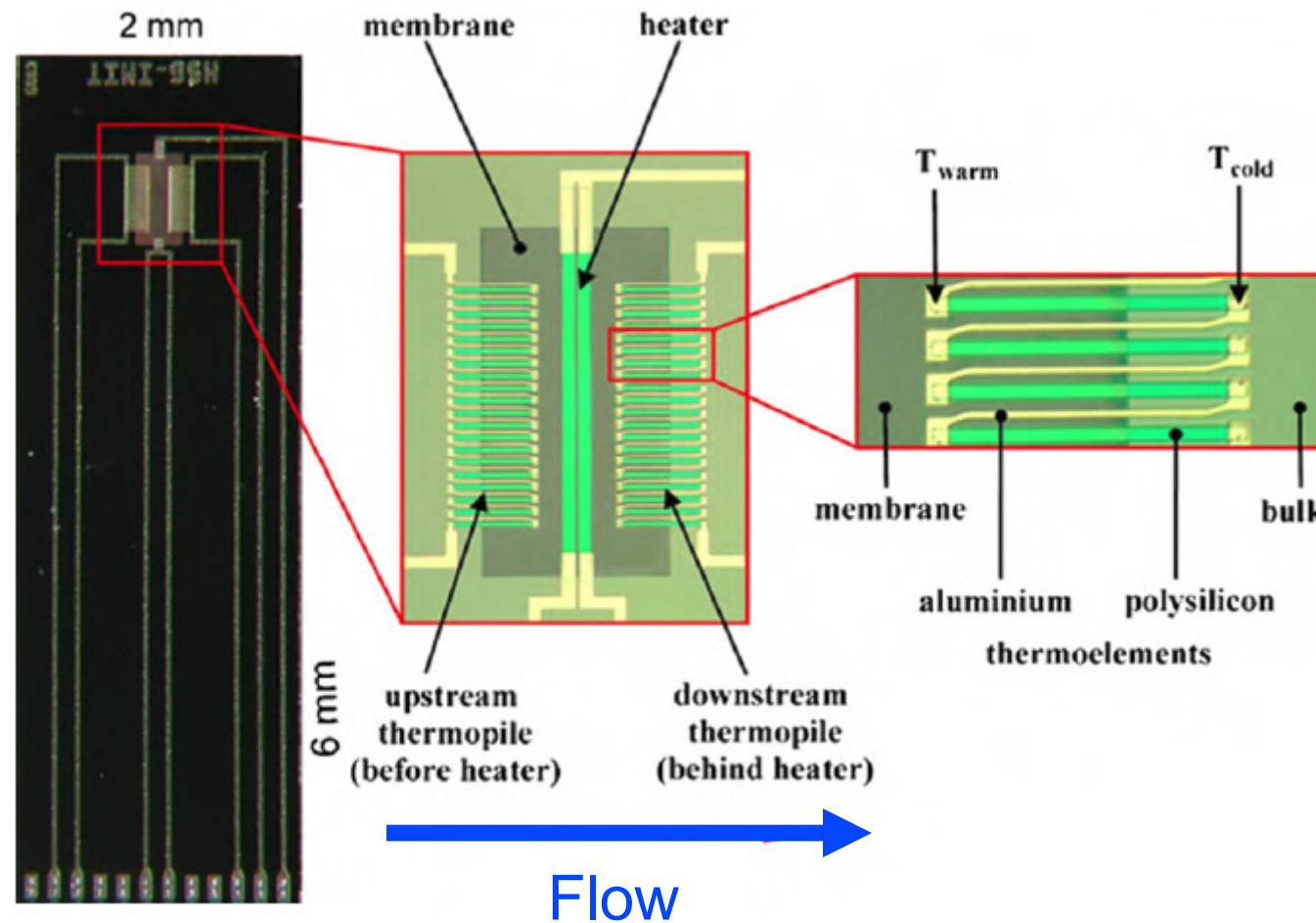

Pencil Graphite Thermal Flow Sensor...

(a) Structure of the sensor

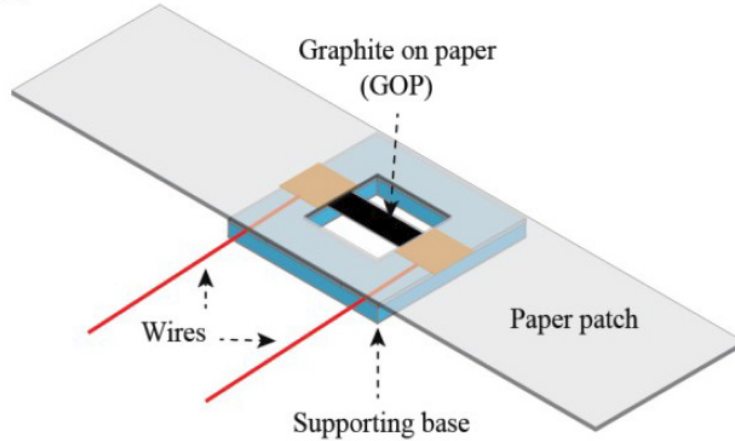

(b) Working principle of the sensor

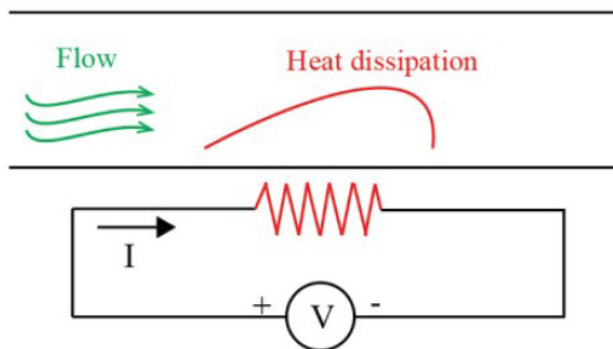

Fabrication process

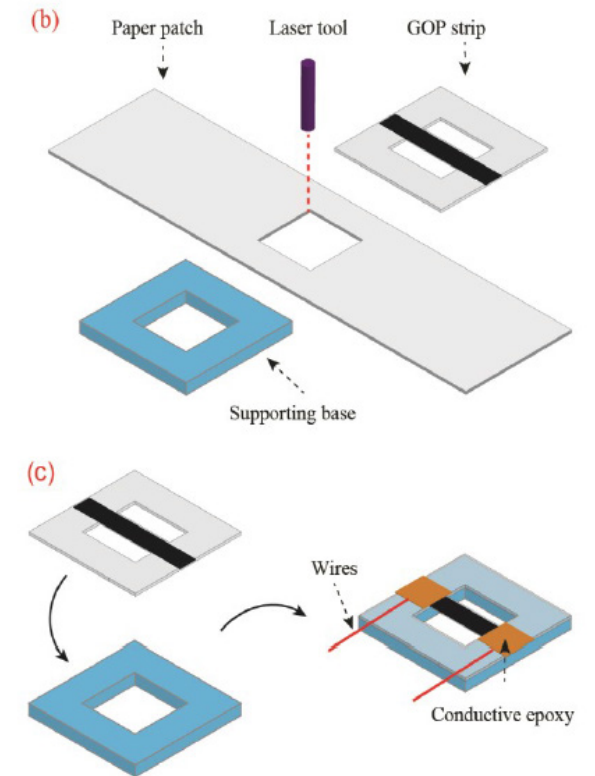
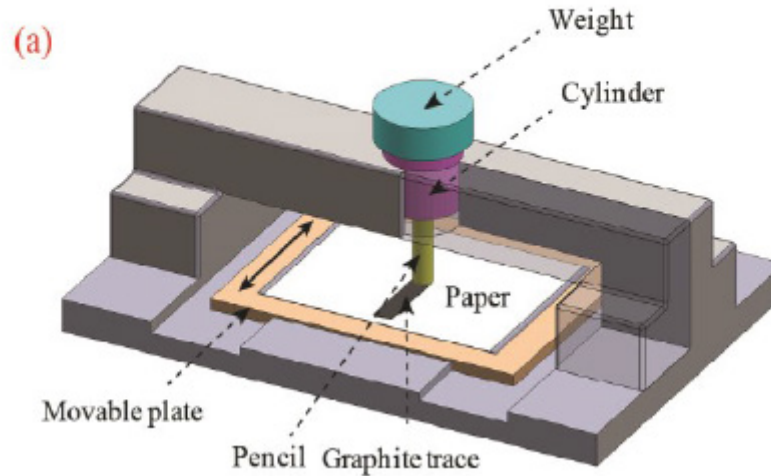

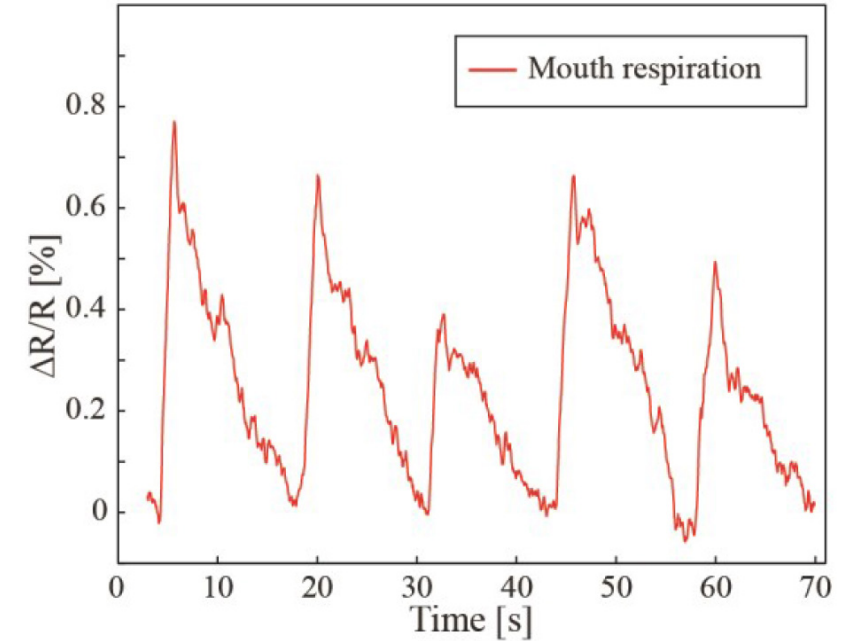
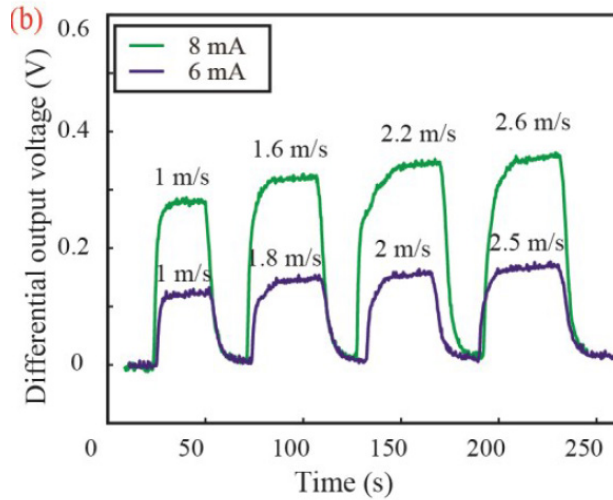
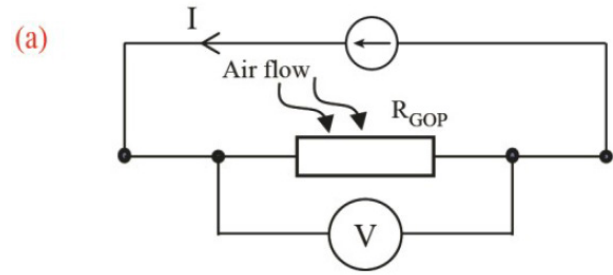
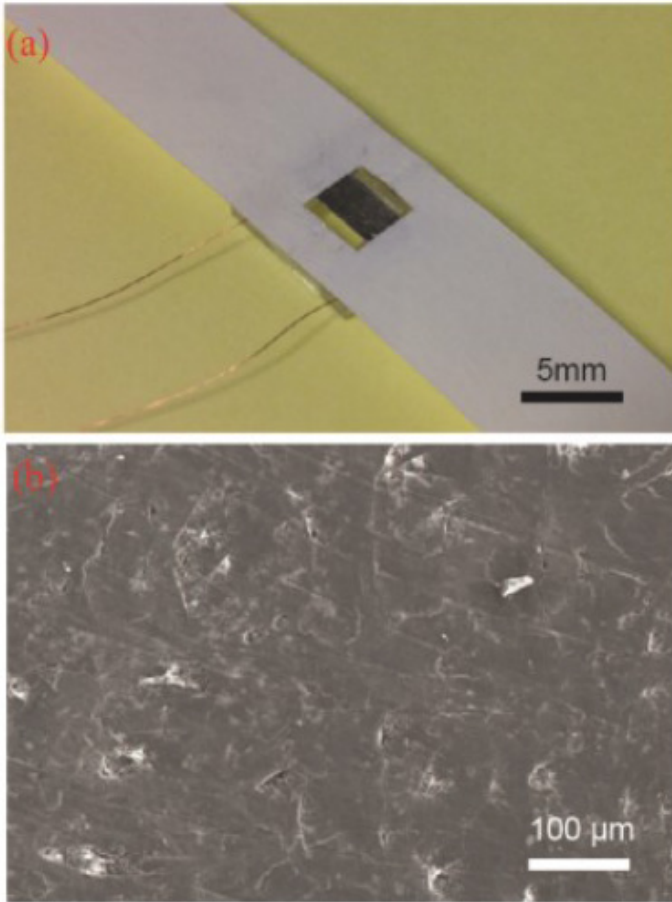

- a) Constant current applied.
- b) Voltage changes with changes in air flow rate.
- c) Human respirations.

Non-Thermal Flow Sensors

- **Cantilever type flow sensors**
 - Measuring the drag-force on a cantilever beam.
- **Differential pressure-based flow sensors**
 - When a fluid flow passes through a duct, or over a surface, it produces a pressure drop depending on the mean velocity of the fluid.
- **Electromagnetic**
- **Laser Doppler flowmeter**
 - The phenomenon is due to the interaction between an electromagnetic or acoustic wave and a moving object: the wave is reflected back showing a frequency different from the incident one.

- Lift-force and drag flow sensors

- Based on the force acting on a body located in a fluid flow.

- Microrotor

- Rotating turbine

- Resonating flow sensors

- Temperature effects resonance frequency of a vibrating membrane.

Cantilever Type Sensor...

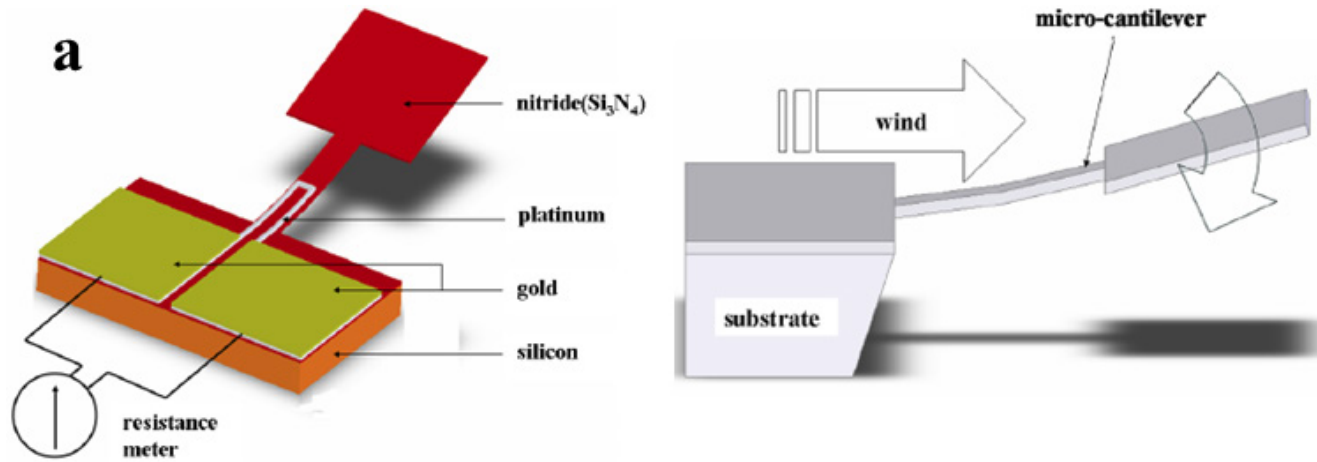

Able to Sense Direction

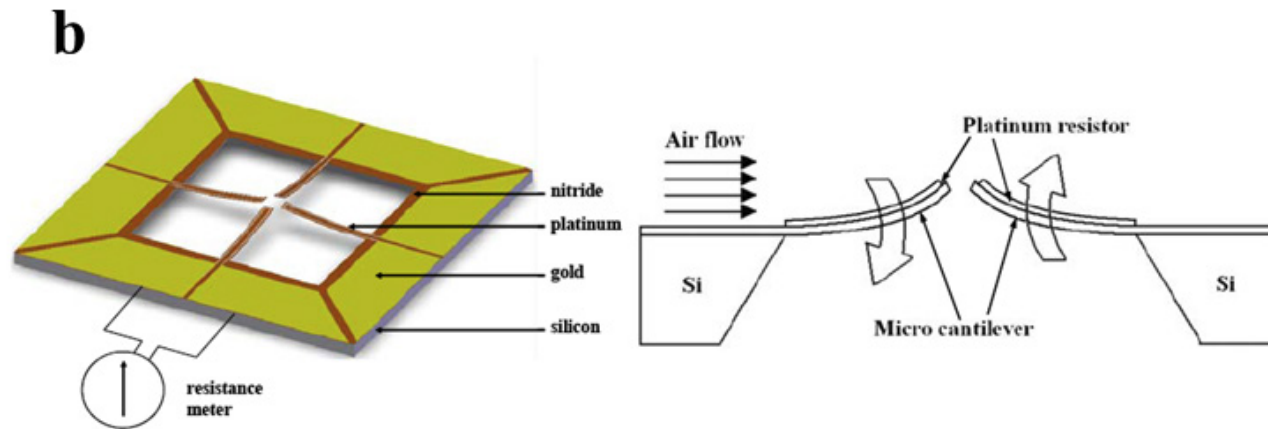

Example -Intravenous Infusion Flow Sensor...

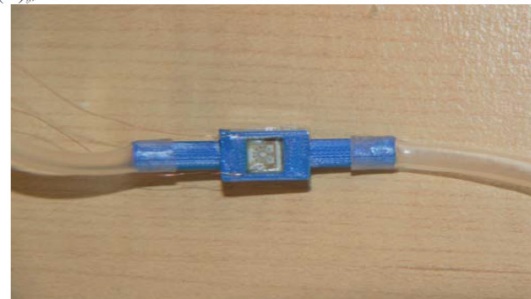
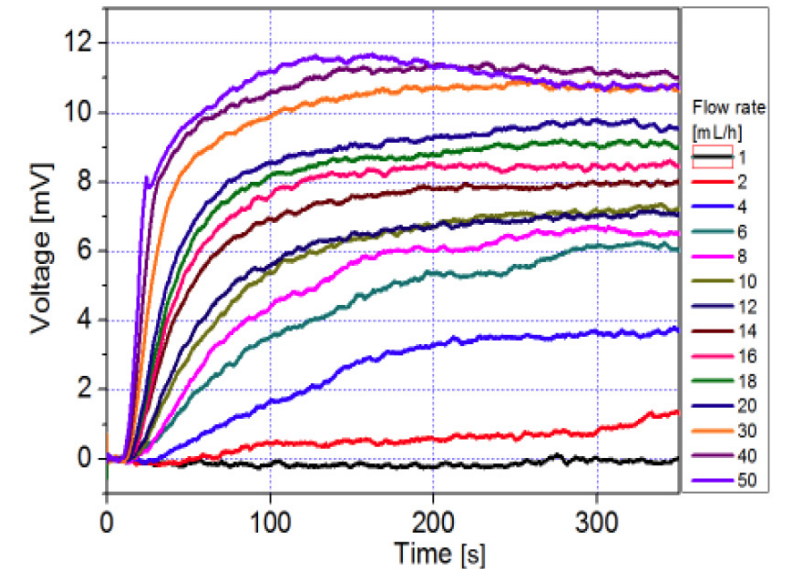
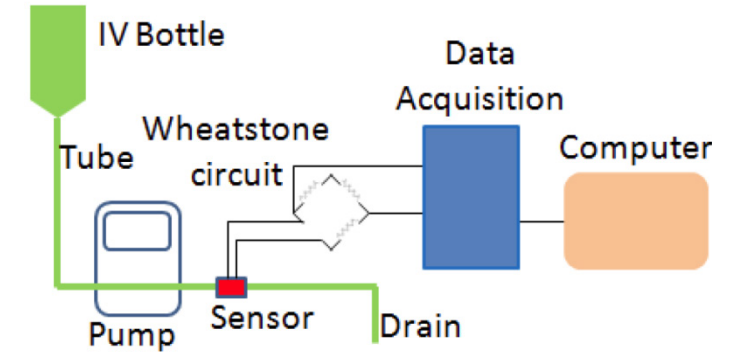
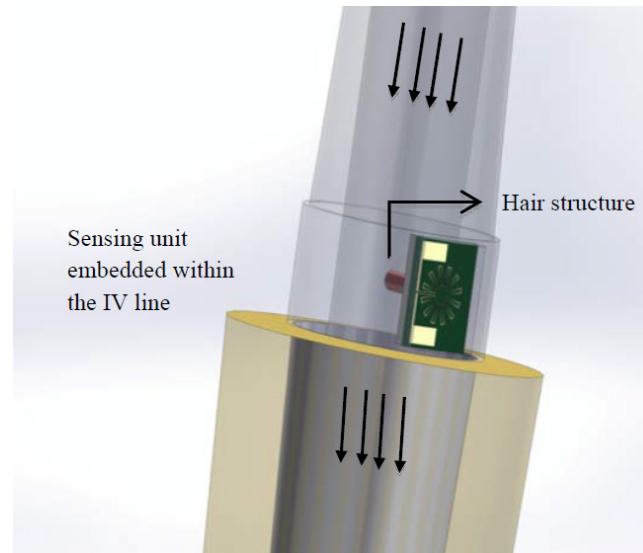
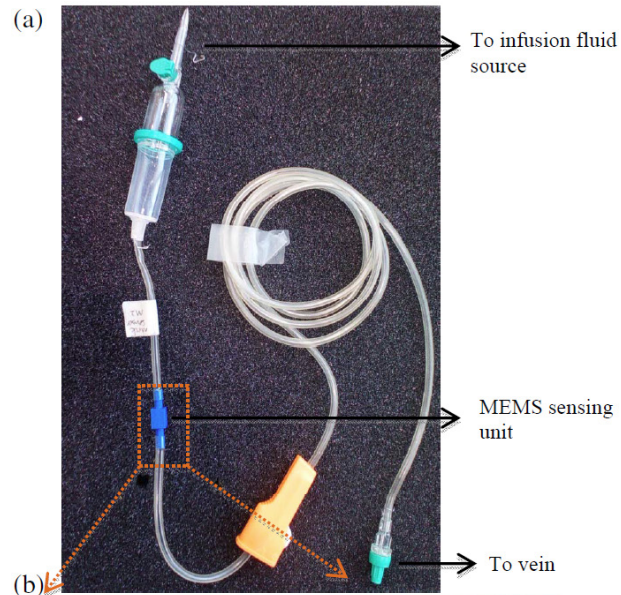

Recommended Reading...



MEMS sensors: Design and Application S. Yellampalli 2018

Key Points

- A thermocouple is a potentiometric device fabricated by the joining of two different metals forming a sensing junction.
 - Based on the thermoelectric Seebeck effect in which a temperature difference in a conductor or semiconductor creates an electric voltage.
- Common force sensors include strain-gage, piezoresistive, piezomagnetic, and capacitive.
- Special sensors incorporate optical, electronic and ionic electroactive, and PZT and PCDF materials.
- Young's Modulus relates stress and strain.

- Piezoresistive sensors are the most common microforce sensor.
 - When a metal or semiconductor material is under stress, its resistance will change proportionally to its deformation.
 - A Wheatstone bridge can be used to translate variation in resistance to voltage.
- A capacitive force sensor measures force by changes in the distance between plates.
- Flow sensing can be done with various thermal techniques, cantilevers, differential pressure, electromagnetic, laser-doppler probes, microrotors and resonating flow sensors.

Appendix

- Sensor flow classifications.
- Common materials & methods for piezoelectric sensors.
- Example interface of the laparoscopic sensor.

Sensor Classification Schemes

- A sensor measures information from the environment (e.g. a blood *analyte*, or *measurand*) and provides an electrical signal in response.
- Sensors may be classified in various ways:
 - **Measurand** - temperature, pressure, flow etc.
 - **Transduction** (physical and chemical effects) - SAW, ion selective FETs, optodes (chemical transducer) etc.
 - **Materials** - resistive, piezoelectric, magnetic, permeable membranes, etc.
 - **Technology** – MEMS, bioMEMS, plasmon resonance, CMOS imaging, charge coupled devices etc.
 - **Energy requirement** - active or passive.
 - **Applications** - industrial, automotive, aviation, consumer electronics, biomedical etc.

Common Methods for Piezoelectric Sensors

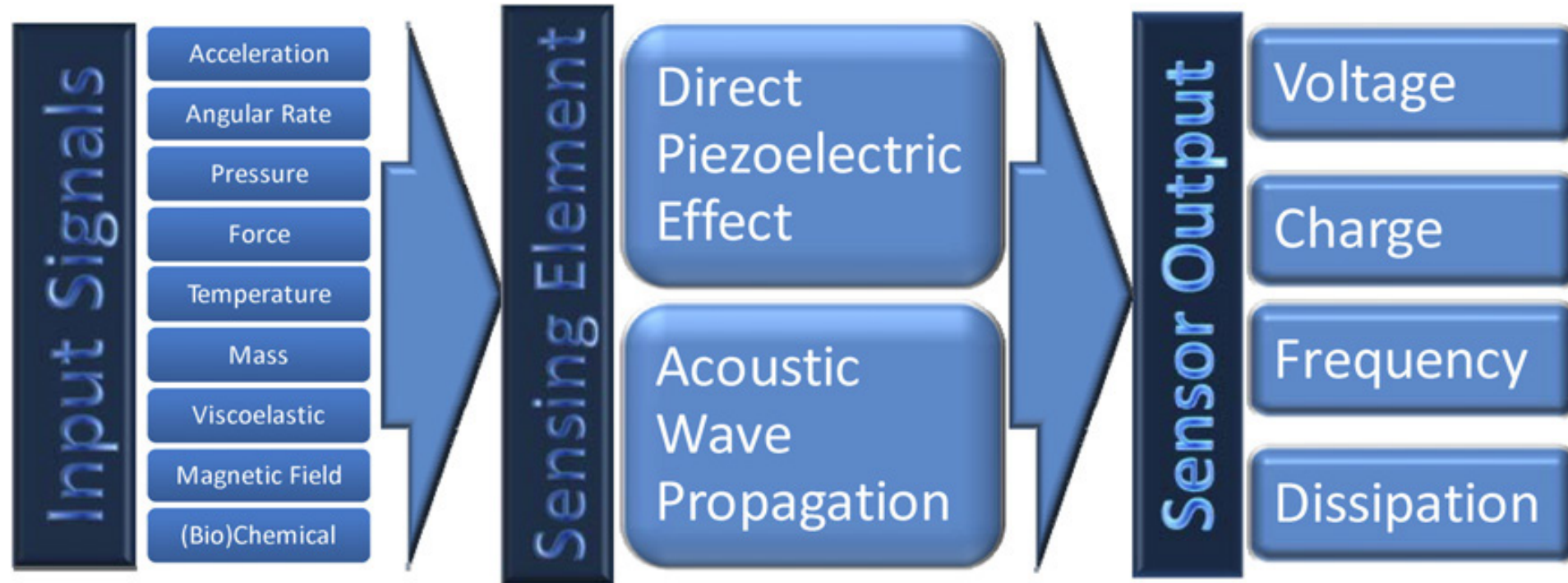

Modeling & Harnessing Piezoelectric Sensor...

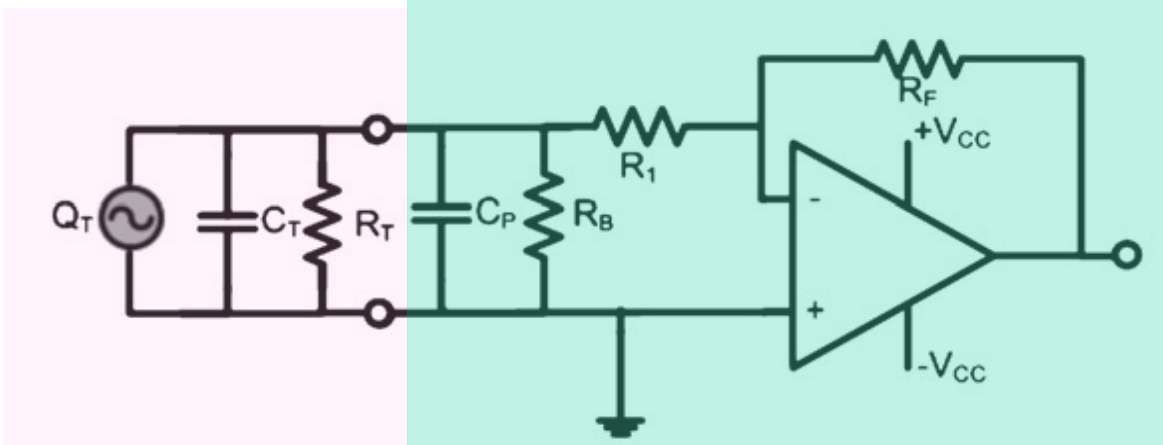

$$V_{Out} = -\frac{Q_T}{C_T + C_P} \left(\frac{R_F}{R_1} \right)$$

Charge source Q_T with a shunt capacitor C_T and resistor R_T
See next slide for explanation.

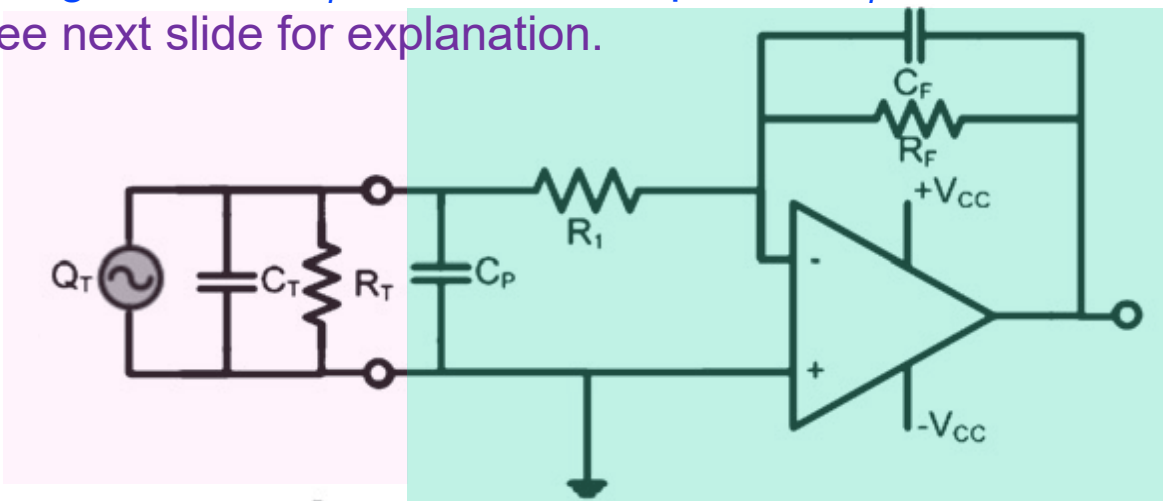

$$V_{Out} = -\frac{Q_T}{C_F}$$

- A piezoelectric sensor can be modeled as a charge source Q_T with a shunt capacitor C_T and resistor R_T or as a voltage source with a series capacitor and resistor.
- The charge produced depends on the piezoelectric constant of the device and the input mechanical signals.
- The capacitance is determined by the area, the width and the dielectric constant of the piezoelectric material.
- The resistance accounts for the dissipation of static charge through leakage.
- Operational amplifier-based circuits can be readily used for amplification of piezoelectric sensors. The voltage amplifier circuit shown in top figure is typically used when the amplifier circuit can be located very close to the transducer and when the effect of the parasitic capacitance C_P can be minimized in the performance of this circuit. The resistor R_B is typically very large and provides the required biasing for the input stage of the circuit.
- The charge amplifier circuit is based on the Miller integrator circuit is shown in the bottom figure. The feedback resistor R_F is required to prevent the circuit from saturating due to the charge build-up on the capacitor C_F . In this circuit, the amplifier keeps the two input terminals at the same voltage, and therefore the parasitic capacitance does not affect this circuit.

Interface of the Laparoscopic Sensor

